

LD-AND-OR

**TÉCNICAS DE
PROGRAMACIÓN**

**EJERCICIOS DE
DIAGRAMAS DE RELÉS**

CURSO DE AUTÓMATAS PROGRAMABLES

EJERCICIO 1:

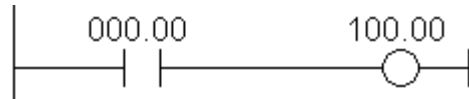

LD	000.00
OUT	100.00

EJERCICIO 2:

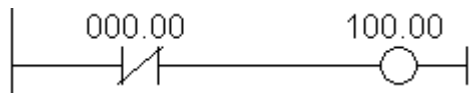

LD NOT	000.00
OUT	100.00

EJERCICIO 3:

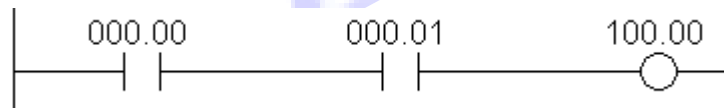

LD	000.00
AND	000.01
OUT	100.00

CURSO DE AUTÓMATAS PROGRAMABLES

EJERCICIO 4:

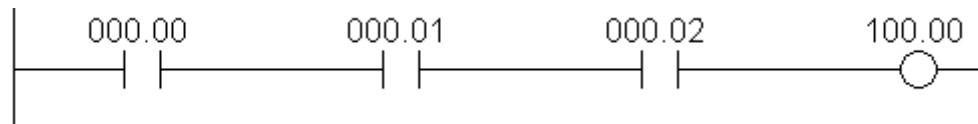

LD	000.00
AND	000.01
AND	000.02
OUT	100.00

EJERCICIO 5:

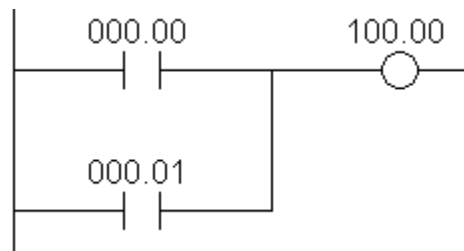

LD	000.00
OR	000.01
OUT	100.00

EJERCICIO 6:

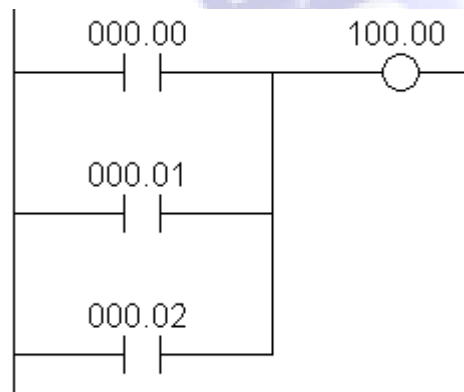

LD	000.00
OR	000.01
OR	000.02
OUT	100.00

CURSO DE AUTÓMATAS PROGRAMABLES

EJERCICIO 7:

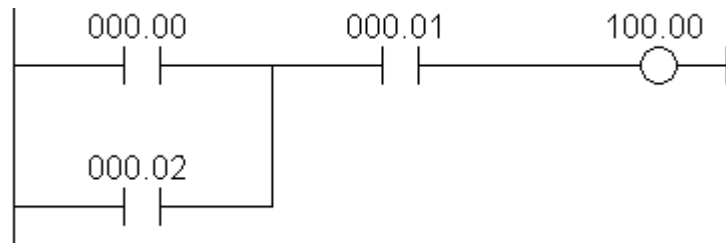

LD	000.00
OR	000.02
AND	000.01
OUT	100.00

EJERCICIO 8:

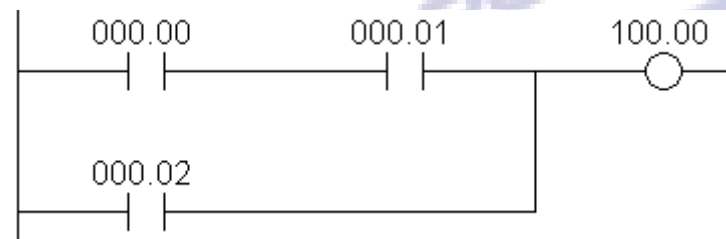

LD	000.00
AND	000.01
OR	000.02
OUT	100.00

EJERCICIO 9:

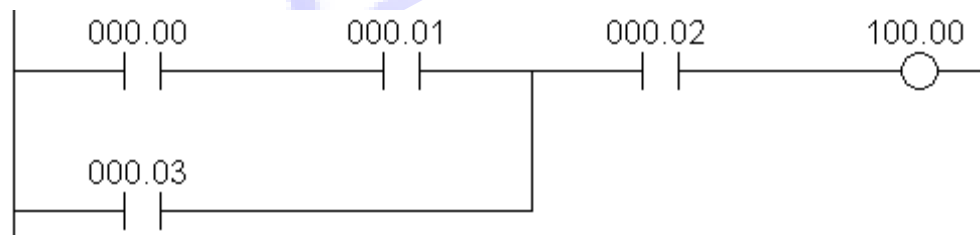

LD	000.00
AND	000.01
OR	000.03
AND	000.02
OUT	100.00

CURSO DE AUTÓMATAS PROGRAMABLES

EJERCICIO 10:

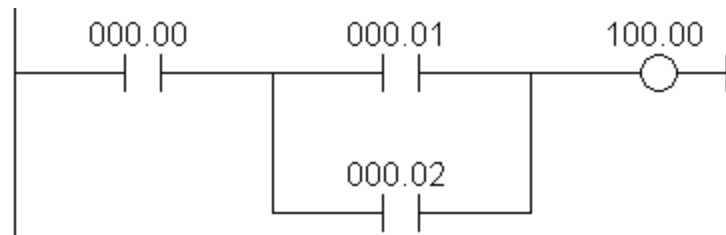

LD	000.00
LD	000.01
OR	000.02
AND LD	
OUT	100.00

EJERCICIO 11:

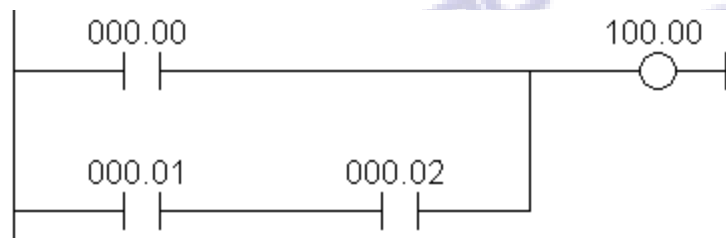

LD	000.00
LD	000.01
AND	000.02
OR LD	
OUT	100.00

EJERCICIO 12:

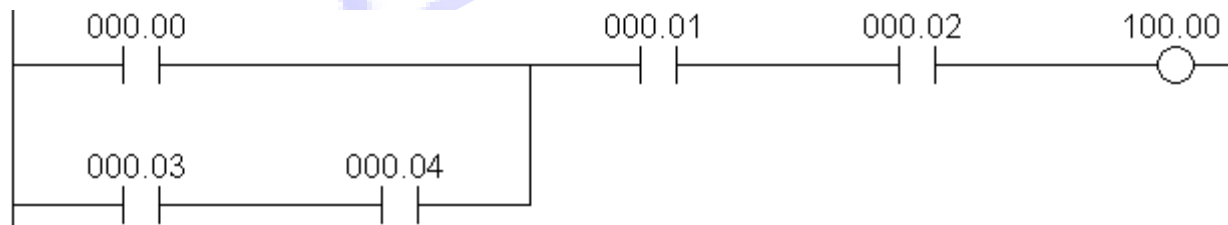

LD	000.00
LD	000.03
AND	000.04
OR LD	
AND	000.01
AND	000.02
OUT	100.00

CURSO DE AUTÓMATAS PROGRAMABLES

EJERCICIO 13:

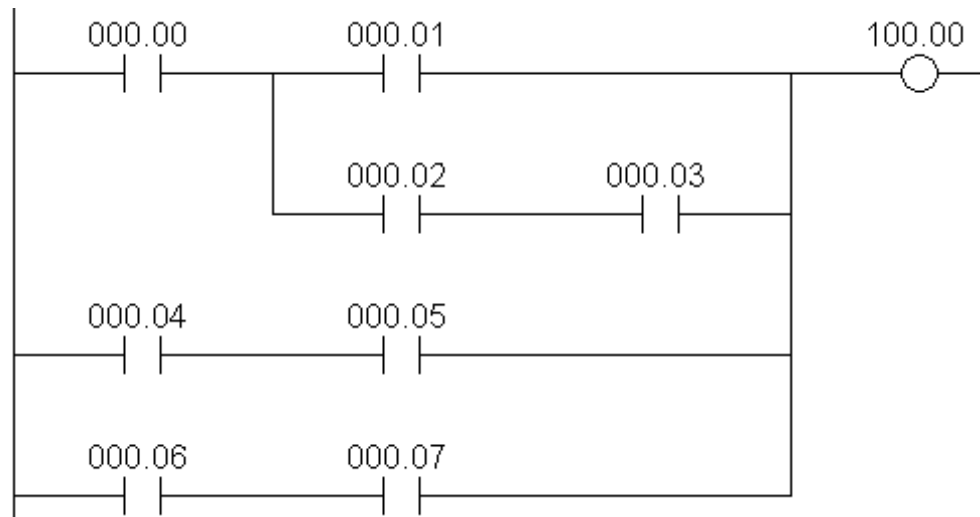

LD	000.00
LD	000.01
LD	000.02
AND	000.03
OR LD	
AND LD	
LD	000.04
AND	000.05
OR LD	
LD	000.06
AND	000.07
OR LD	
OUT	100.00

CURSO DE AUTÓMATAS PROGRAMABLES

EJERCICIO 14:

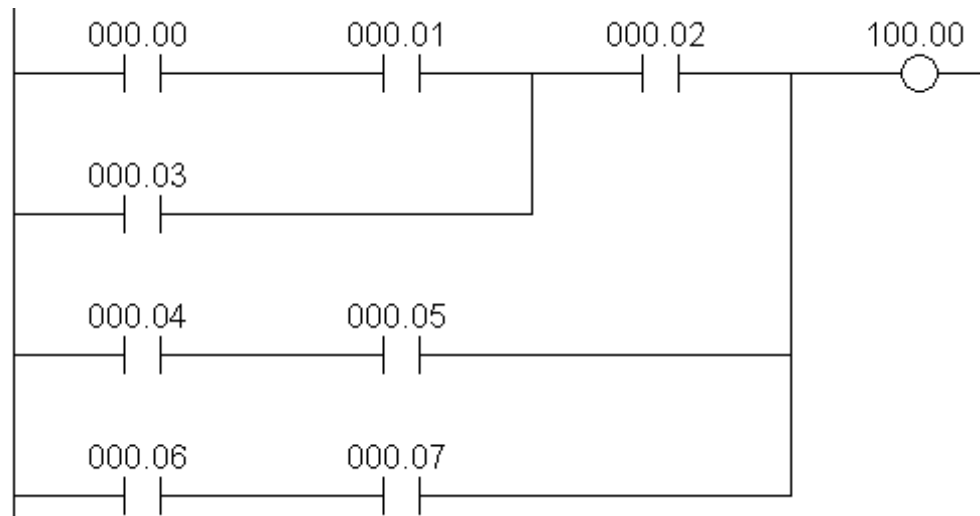

LD	000.00
AND	000.01
OR	000.03
AND	000.02
LD	000.04
AND	000.05
OR LD	
LD	000.06
AND	000.07
OR LD	
OUT	100.00

CURSO DE AUTÓMATAS PROGRAMABLES

EJERCICIO 15:

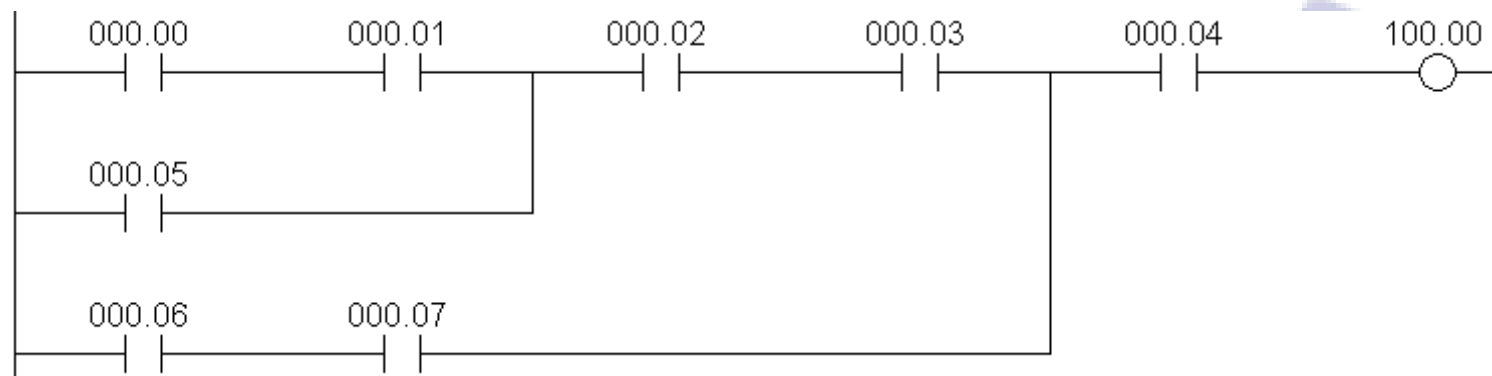

LD	000.00	LD	000.06
AND	000.01	AND	000.07
OR	000.05	OR LD	
AND	000.02	AND	000.04
AND	000.03	OUT	100.00

CURSO DE AUTÓMATAS PROGRAMABLES

EJERCICIO 16:

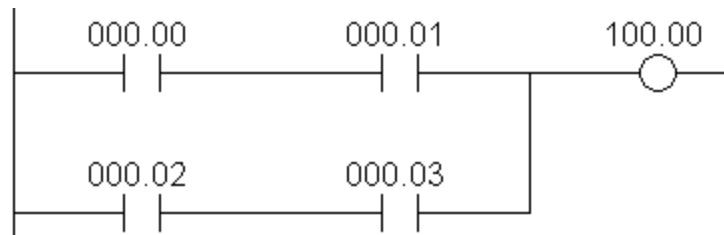

LD	000.00
AND	000.01
LD	000.02
AND	000.03
OR LD	
OUT	100.00

EJERCICIO 17:

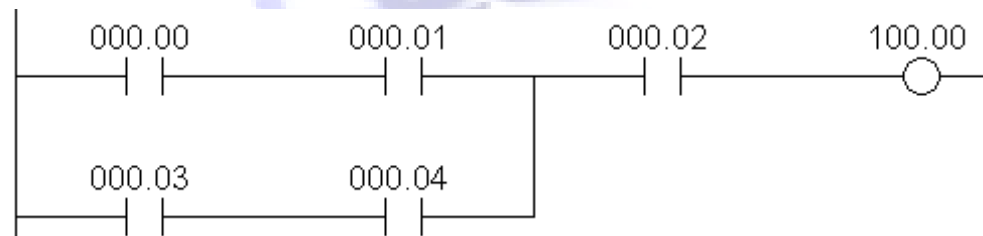

LD	000.00
AND	000.01
LD	000.03
AND	000.04
OR LD	
AND	000.02
OUT	100.00

CURSO DE AUTÓMATAS PROGRAMABLES

EJERCICIO 18:

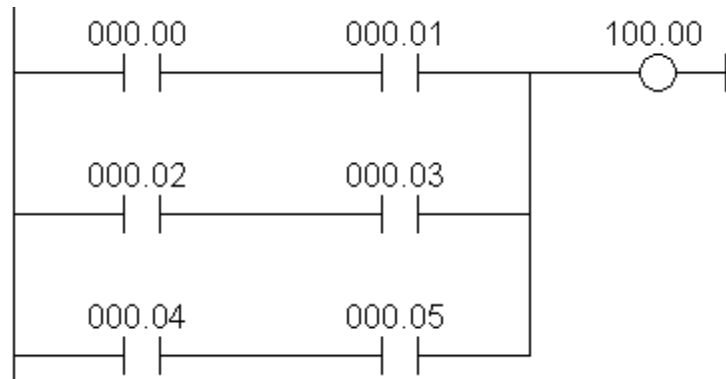

LD	000.00
AND	000.01
LD	000.02
AND	000.03
OR LD	
LD	000.04
AND	000.05
OR LD	
OUT	100.00

EJERCICIO 19:

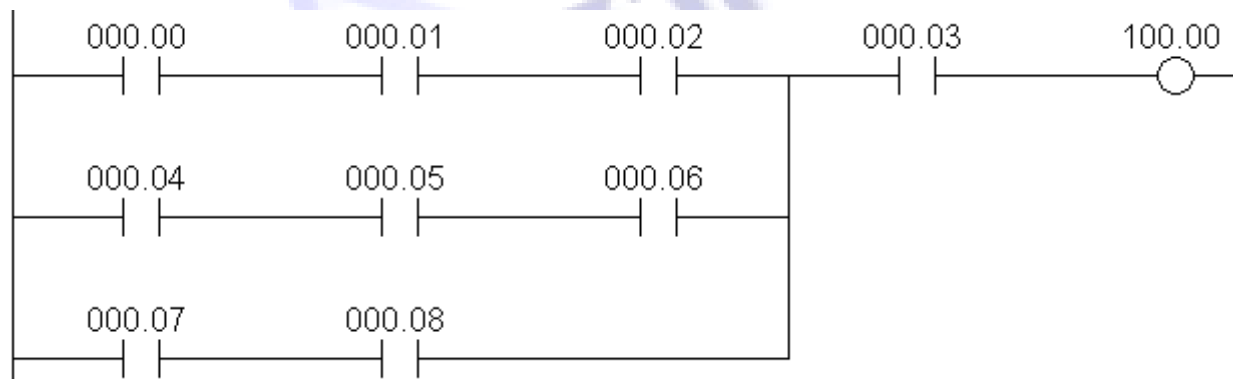

LD	000.00
AND	000.01
AND	000.02
LD	000.04
AND	000.05
AND	000.06
OR LD	
LD	000.07
AND	000.08
OR LD	
AND	000.03
OUT	100.00

CURSO DE AUTÓMATAS PROGRAMABLES

EJERCICIO 20:

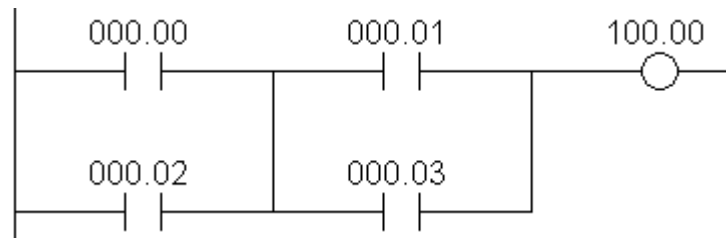

LD	000.00
OR	000.02
LD	000.01
OR	000.03
AND LD	
OUT	100.00

EJERCICIO 21:

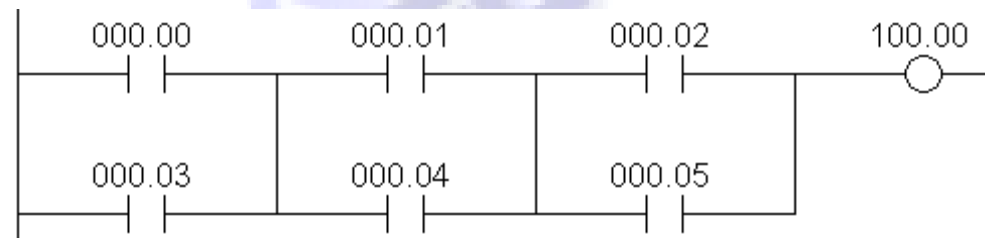

LD	000.00
OR	000.03
LD	000.01
OR	000.04
AND LD	
LD	000.02
OR	000.05
AND LD	
OUT	100.00

CURSO DE AUTÓMATAS PROGRAMABLES

EJERCICIO 22:

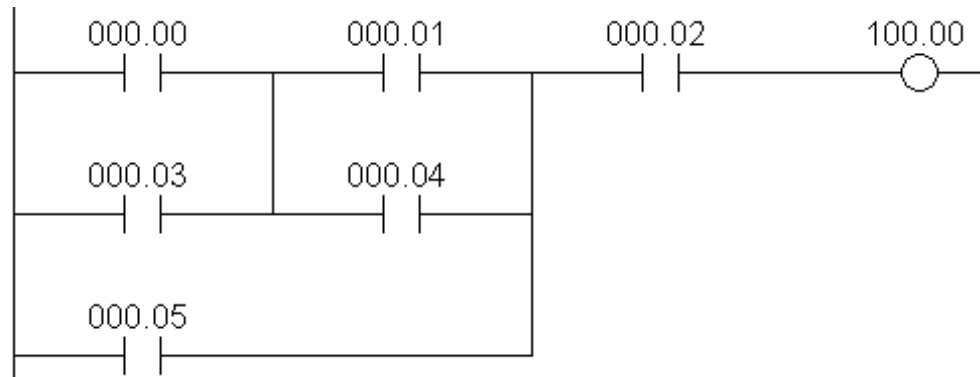

LD	000.00
OR	000.03
LD	000.01
OR	000.04
AND LD	
OR	000.05
AND	000.02
OUT	100.00

EJERCICIO 23:

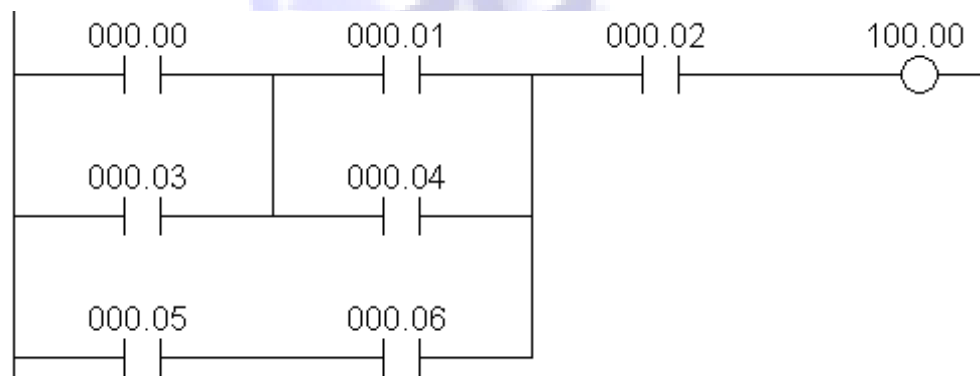

LD	000.00
OR	000.03
LD	000.01
OR	000.04
AND LD	
LD	000.05
AND	000.06
OR LD	
AND	000.02
OUT	100.00

CURSO DE AUTÓMATAS PROGRAMABLES

EJERCICIO 24:

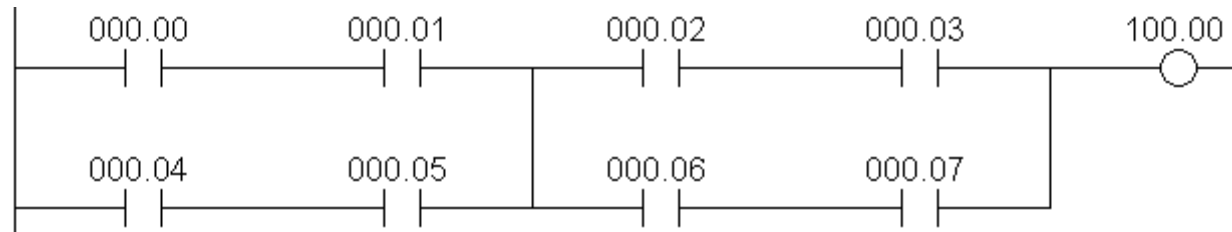

LD	000.00	AND	000.03
AND	000.01	LD	000.06
LD	000.04	AND	000.07
AND	000.05	OR LD	
OR LD		AND LD	
LD	000.02	OUT	100.00

CURSO DE AUTÓMATAS PROGRAMABLES

EJERCICIO 25:

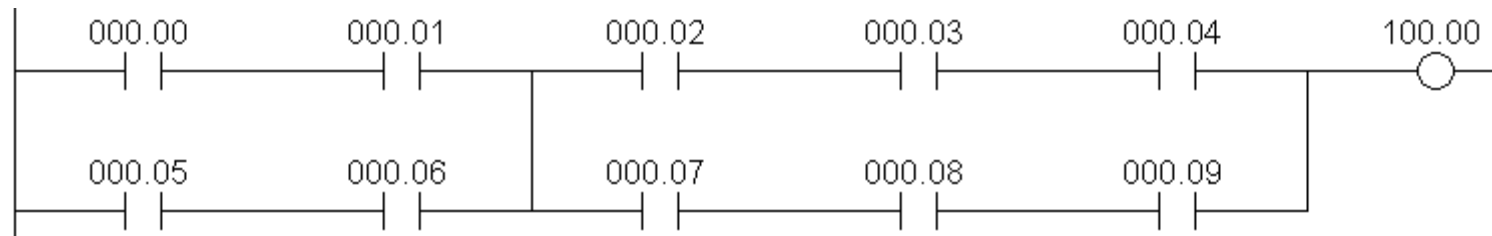

LD	000.00	AND	000.04
AND	000.01	LD	000.07
LD	000.05	AND	000.08
AND	000.06	AND	000.09
OR LD		OR LD	
LD	000.02	AND LD	
AND	000.03	OUT	100.00

CURSO DE AUTÓMATAS PROGRAMABLES

EJERCICIO 26:

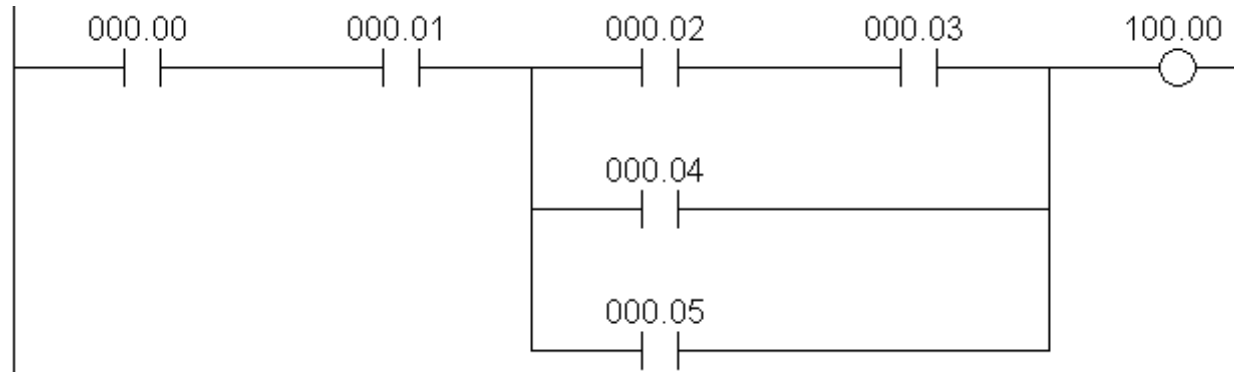

LD	000.00
AND	000.01
LD	000.02
AND	000.03
OR	000.04
OR	000.05
AND LD	
OUT	100.00

EJERCICIO 27:

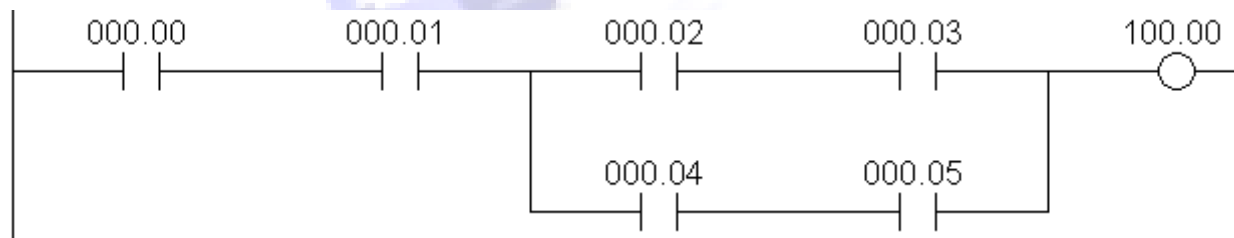

LD	000.00
AND	000.01
LD	000.02
AND	000.03
LD	000.04
AND	000.05
OR LD	
AND LD	
OUT	100.00

CURSO DE AUTÓMATAS PROGRAMABLES

EJERCICIO 28:

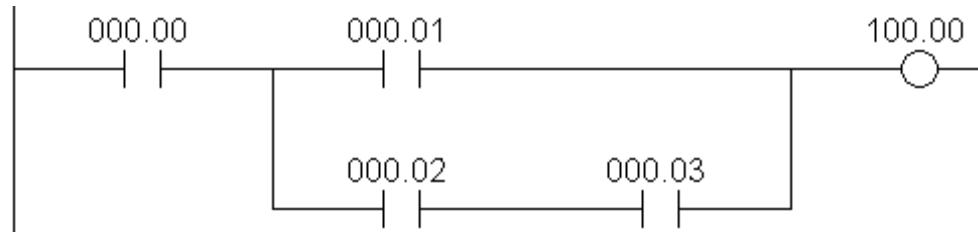

LD	000.00
LD	000.01
LD	000.02
AND	000.03
OR LD	
AND LD	
OUT	100.00

CURSO DE AUTÓMATAS PROGRAMABLES

EJERCICIO 29:

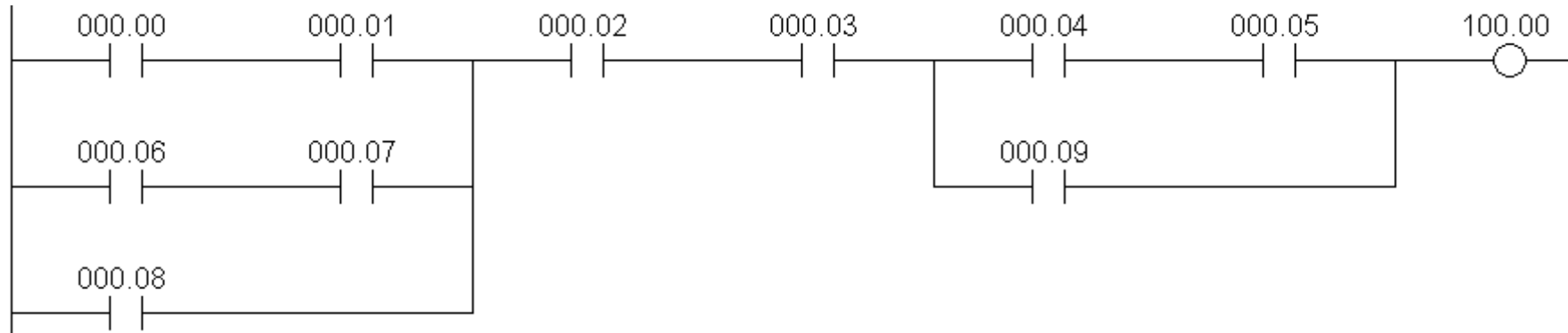

LD	000.00	AND	000.03
AND	000.01	LD	000.04
LD	000.06	AND	000.05
AND	000.07	OR	000.09
OR LD		AND LD	
OR	000.08	OUT	100.00
AND	000.02		

CURSO DE AUTÓMATAS PROGRAMABLES

EJERCICIO 30:

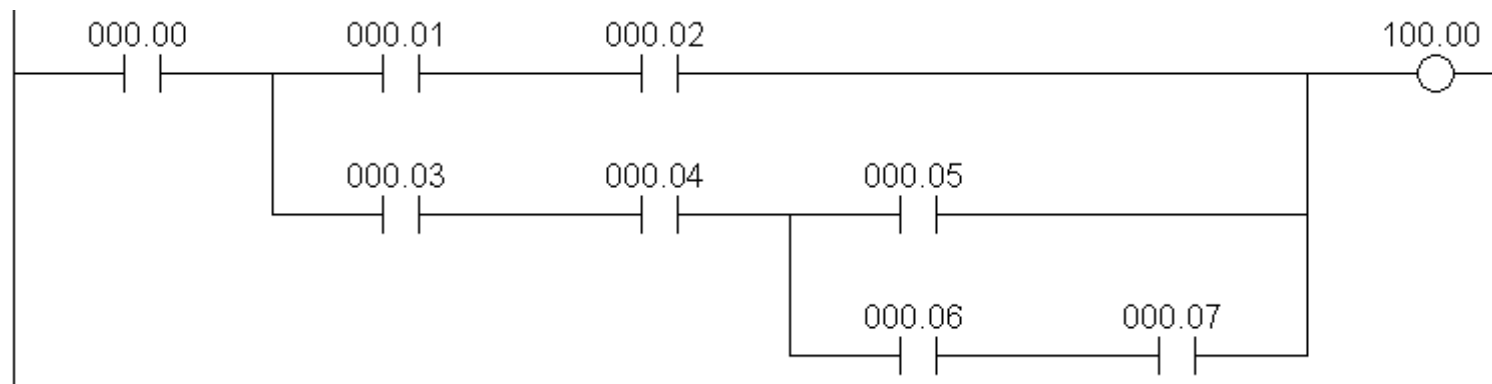

LD	000.00	AND	000.07
LD	000.01	OR LD	
AND	000.02	AND LD	
LD	000.03	OR LD	
AND	000.04	AND LD	
LD	000.05	OUT	100.00
LD	000.06		

CURSO DE AUTÓMATAS PROGRAMABLES

EJERCICIO 30-bis:

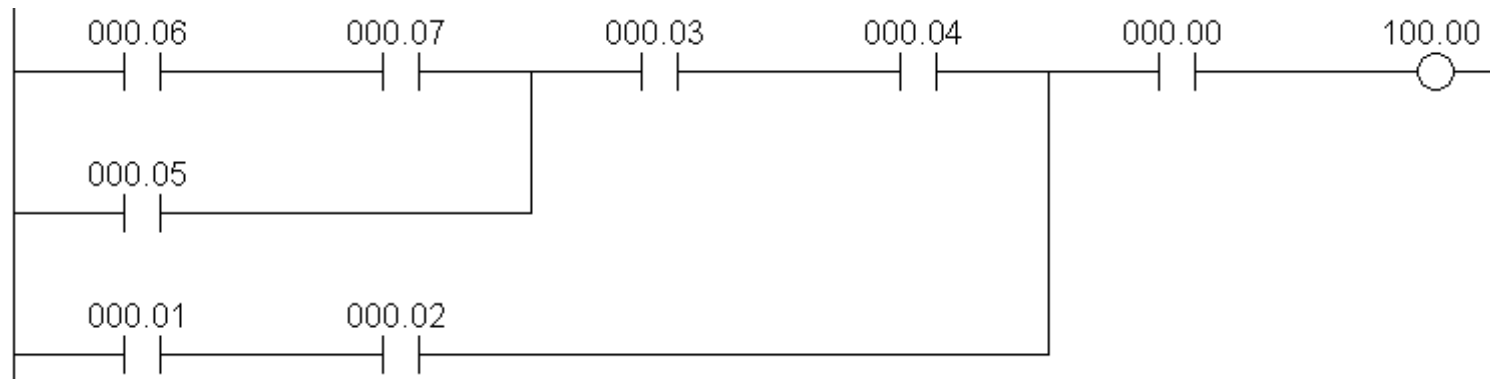

LD	000.06	LD	000.01
AND	000.07	AND	000.02
OR	000.05	OR LD	
AND	000.03	AND	000.00
AND	000.04	OUT	100.00

CURSO DE AUTÓMATAS PROGRAMABLES

EJERCICIO 31:

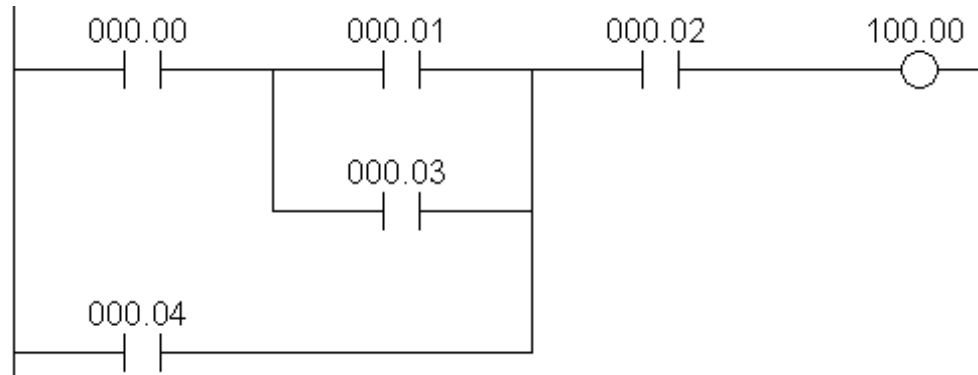

LD	000.00
LD	000.01
OR	000.03
AND LD	
OR	000.04
AND	000.02
OUT	100.00

EJERCICIO 32:

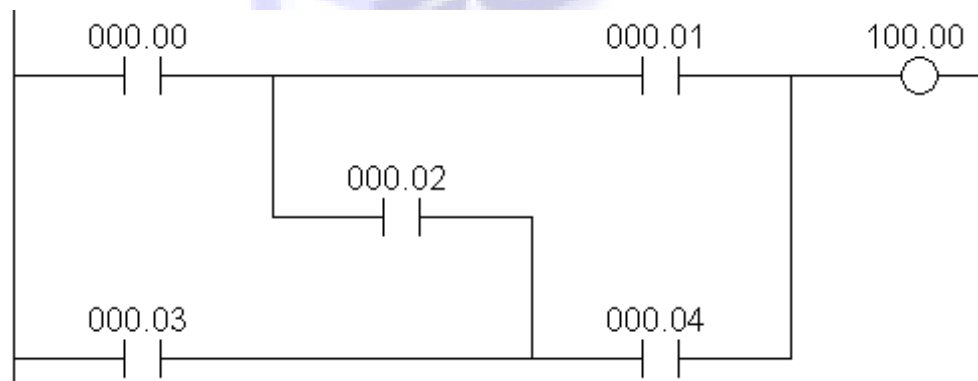

??????????

CURSO DE AUTÓMATAS PROGRAMABLES

EJERCICIO 32-bis:

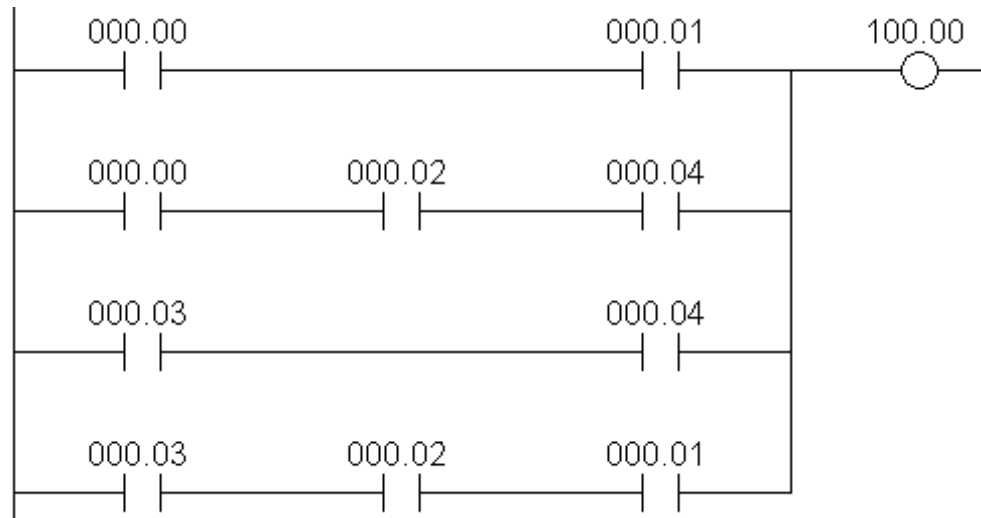

LD	000.00
AND	000.01
LD	000.00
AND	000.02
AND	000.04
OR LD	
LD	000.03
AND	000.04
OR LD	
LD	000.03
AND	000.02
AND	000.01
OR LD	
OUT	100.00

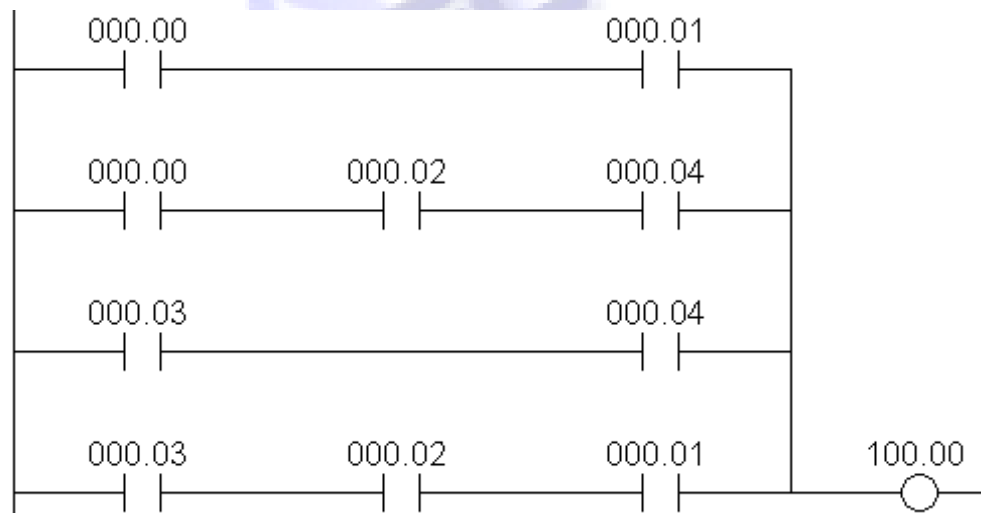

CURSO DE AUTÓMATAS PROGRAMABLES

EJERCICIO 32-bis:

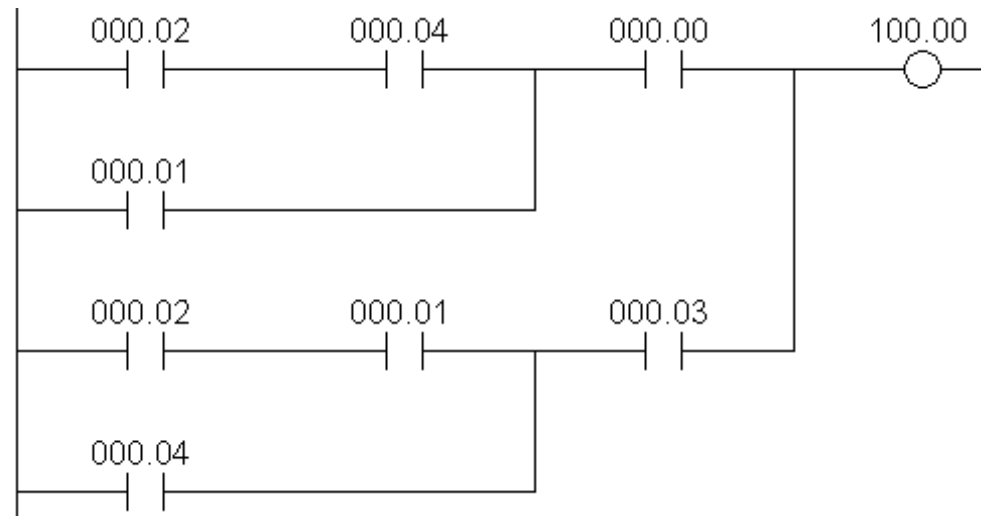

LD	000.02
AND	000.04
OR	000.01
AND	000.00
LD	000.02
AND	000.01
OR	000.04
AND	000.03
OR LD	
OUT	100.00