

**SYSMAC**

**C500-CP131  
Cam Positioner Unit**

**OPERATION MANUAL**

**OMRON**

# Cam Positioner Unit Operation Manual

Revised February 1990

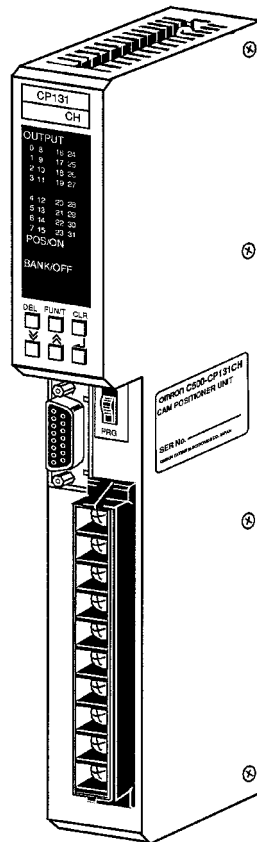

**Prepared for OMRON by:**

Bruce Dow  
Michiko Takenaka  
Dan Schneider  
**DATEC, Inc.**



# Notice

OMRON products are manufactured for use according to proper procedures by a qualified operator and only for the purposes described in this manual.

The following conventions are used to indicate and classify notes of particular interest in this manual. Always heed the information provided with them.

**DANGER!** Indicates information that, if not heeded, could result in loss of life or serious injury.

**Caution** Indicates information that, if not heeded, could result in minor injury or damage to the product.

**Note** Indicates information of particular interest for efficient and convenient operation of the product.

**1, 2, 3...** Indicates that the following information will be displayed in list format.

©OMRON, 1989

All rights reserved. No part of this publication may be reproduced, stored in a retrieval system, or transmitted, in any form, or by any means, mechanical, electronic, photocopying, recording, or otherwise, without the prior written permission of OMRON.

No patent liability is assumed with respect to the use of the information contained herein. Moreover, because OMRON is constantly striving to improve its high-quality products, the information contained in this manual is subject to change without notice. Every precaution has been taken in the preparation of this manual. Nevertheless, OMRON assumes no responsibility for errors or omissions. Neither is any liability assumed for damages resulting from the use of the information contained in this publication.



# TABLE OF CONTENTS

## SECTION 1

<b>Hardware Description</b> .....	<b>1</b>
1-1 Description of All Components .....	2
1-2 Assembly Instructions .....	4
1-3 System Connections .....	5

## SECTION 2

<b>Functions</b> .....	<b>11</b>
2-1 Overview of Functions .....	12
2-2 Implementation .....	13
2-3 Programming .....	36

## SECTION 3

<b>Troubleshooting</b> .....	<b>47</b>
3-1 System Errors .....	48
3-2 Program Errors .....	49
3-3 Communication Errors .....	50
3-4 Error Code Transfer .....	51

## Appendices

A Specifications .....	53
B Standard Models .....	61
<b>Glossary</b> .....	<b>63</b>
<b>INDEX</b> .....	<b>67</b>
<b>Manual Revision History</b> .....	<b>69</b>



## ***About this Manual...***

This manual explains the Cam Positioner, a Special I/O Unit for the C500, C1000H, and C2000H C-series Programmable Controllers. This manual provides a complete description of the installation, setup, and operation of the Cam Positioner. This manual explains the Cam Positioner, a Special I/O Unit for the C500, C1000H, and C2000H C-series Programmable Controllers. This manual provides a complete description of the installation, setup, and operation of the Cam Positioner.

**Section 1** provides a complete hardware description of the Cam Positioner. All parts of the Unit are described, followed by instructions on how to install the Unit and make the proper connections to it.

**Section 2** contains a functional description of the Cam Positioner. All functions are described, along with information on how these functions should be used. PC Programming is also covered.

**Section 3** explains how to troubleshoot the Cam Positioner. Handling of all errors is covered. Use this section to solve any problems you may encounter.





# SECTION 1

## Hardware Description

1-1	Description of All Components .....	2
1-2	Assembly Instructions .....	4
1-3	System Connections .....	5
1-3-1	Precautions in Wiring and Connection .....	5
1-3-2	Resolver Wiring .....	6
1-3-3	Cam Positioner Wiring .....	8
1-3-4	Coupling Connection .....	9

# Section Overview

The Cam Positioner is a Special I/O Unit for use with C500, C1000H, and C2000H Programmable Controllers (PCs). The Cam Positioner accepts information regarding the angle, speed, and direction of rotation of a mechanical system via a Resolver. The Cam Positioner uses this information to control a system according to cam data stored in the Cam Positioner's internal memory and according to the program running on the PC. The Cam Positioner has 32 output points. Eight of these are through terminals on the front panel of the Cam Positioner, and allow control independent of the PC's scan time. The data for the remaining output points is sent to the CPU of the PC to be handled by the program. The Cam Positioner has its own RUN and PRoGram modes (independent of the CPU mode), and also has its own set of FUNctions that are completely independent of the CPU FUNctions.

## 1-1 Description of All Components

### Front Panel

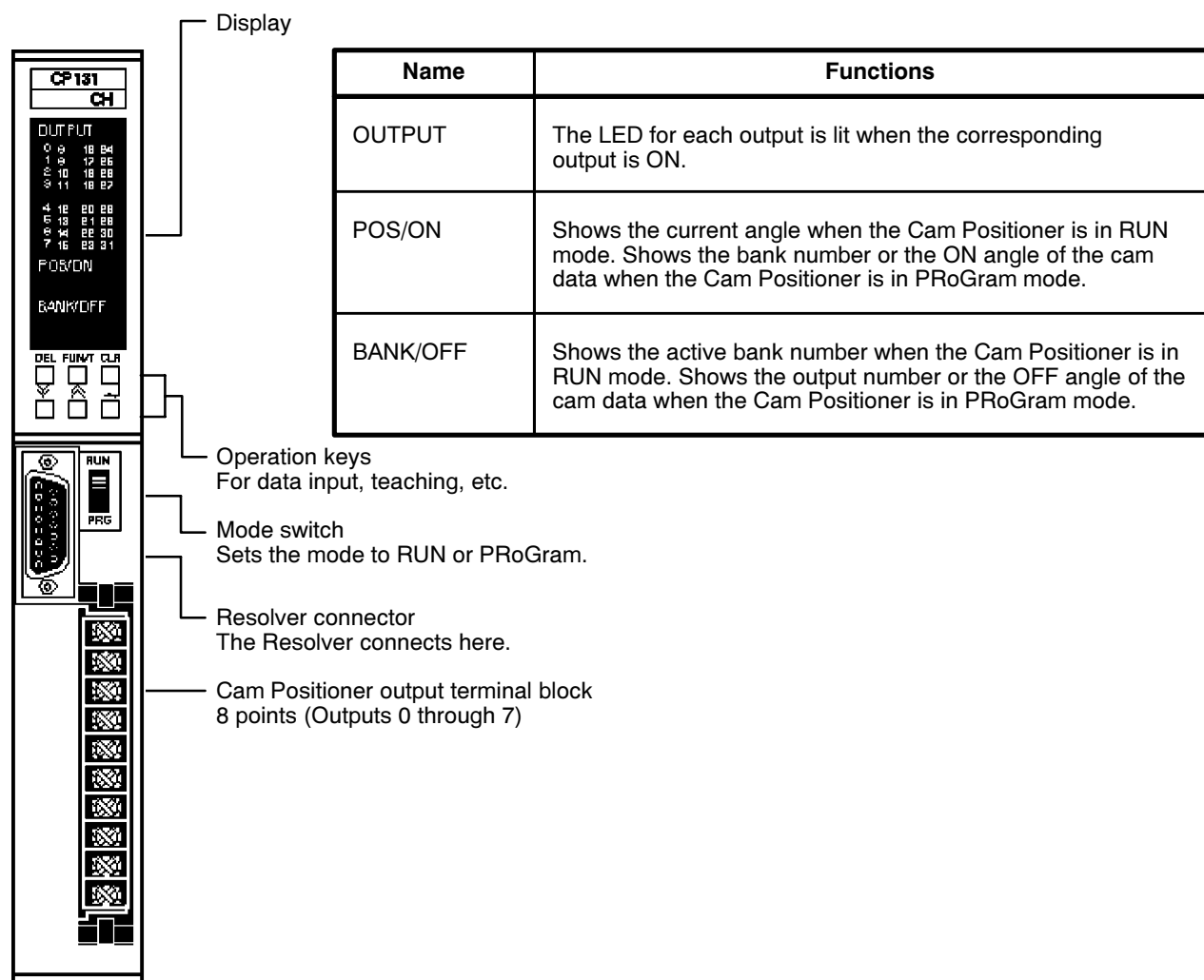

### Back Panel

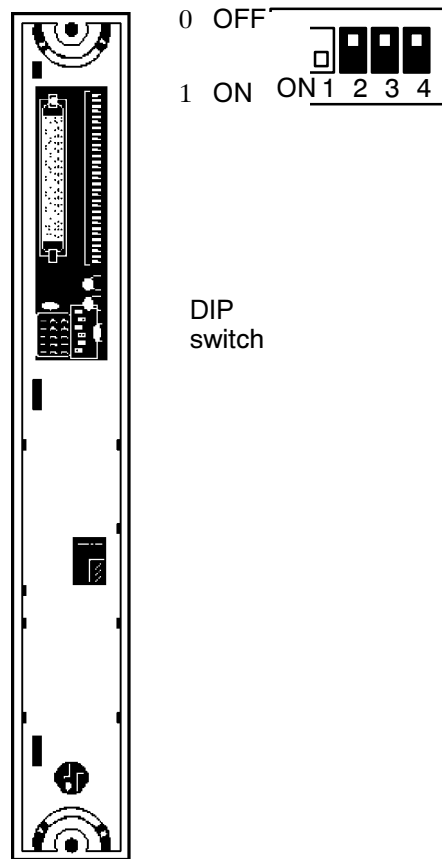

### Internal Block Diagram

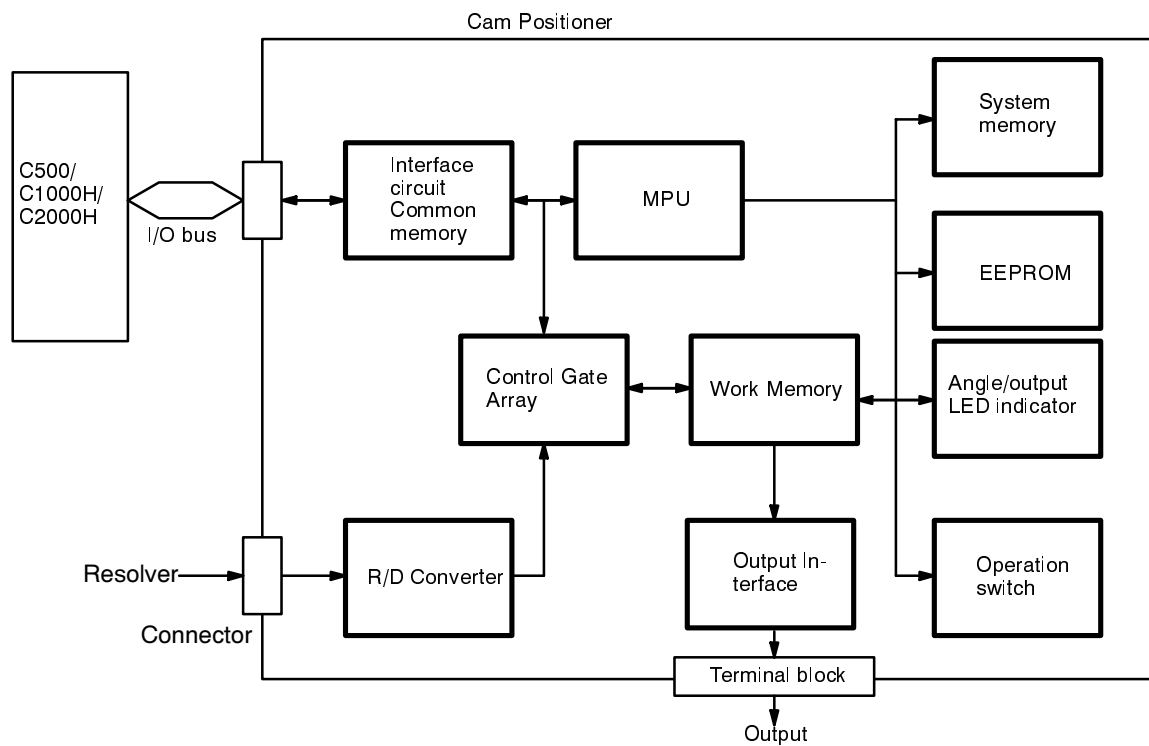

# 1-2 Assembly Instructions

The Cam Positioner reads in data about the angle, speed, and direction of rotation of a mechanical system via a Resolver. The Cam Positioner uses this input to send ON/OFF signals to the controlled system according to the data registered in the internal memory of the Cam Positioner.

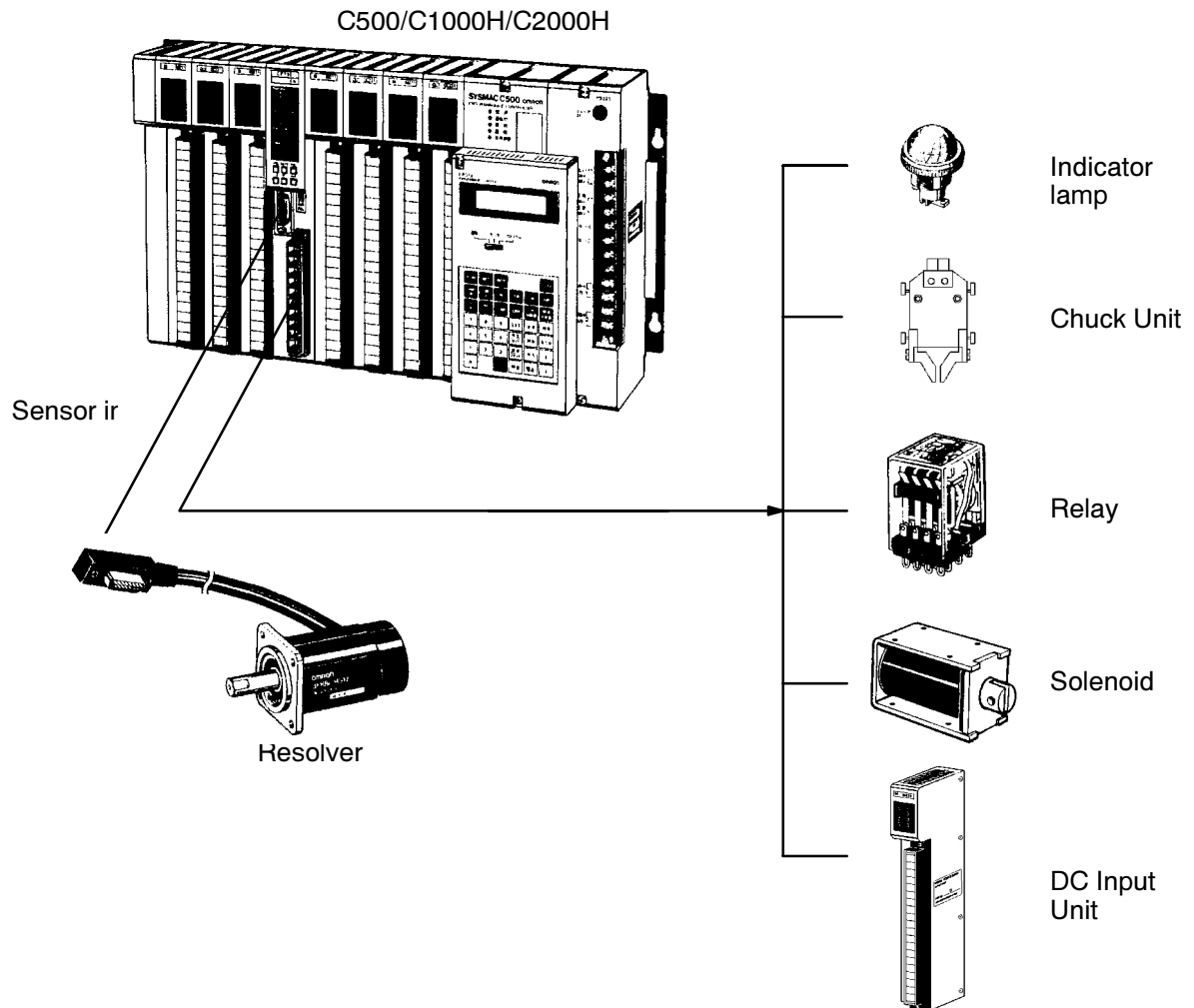

# 1-3 System Connections

## 1-3-1 Precautions in Wiring and Connection

Errors caused by noise may occur in any electronic control device. This is usually due to power lines, external loads, etc. Carry out the following steps to avoid errors caused by noise:

1,2,3...

1. Use cables of the rated diameter, when specified.
2. Be sure to keep power lines (AC supply, motor power lines) and the control lines (Resolver signal lines, external output lines) separate when wiring. Do not put them in the same duct, or bundle them together.
3. Use shielded wire for the control lines.
4. Be sure to use a surge suppressor on inductive loads (contacts, solenoids, solenoid valves, etc.)
5. When electric welders, discharge processors, etc. must use the same power source as the Cam Positioner, or when a high-frequency noise source exists nearby, insert a noise filter at the point where the power enters the PC.
6. Twisted-pair wire is recommended for the power line.
7. Supply grounding at a resistance of no more than 100 Ω using wire at least 1.25 mm in diameter.

**Note** Connect a surge-suppressing diode or surge suppressor, close to any relays or solenoids. The surge-suppressing diode or surge suppressor must be able to absorb a minimum of 5 times the circuit voltage.

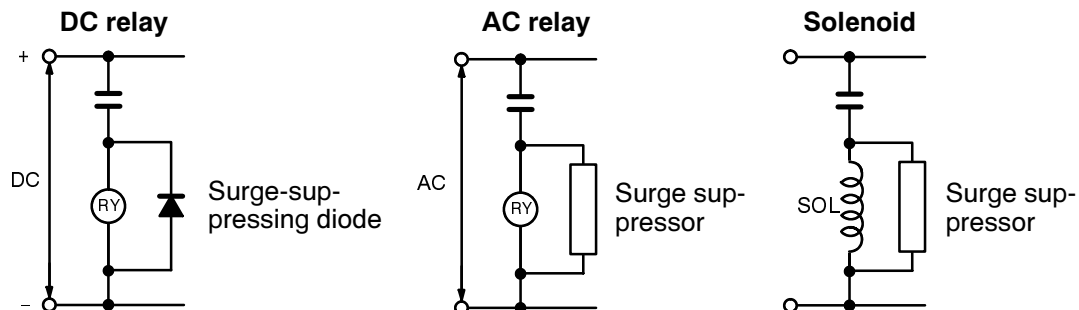

### Use the Following to Make Connections

I/O lines	Cable
Outputs: 0 through 7	0.3 to 1.25 mm <sup>2</sup>
12 to 30 VDC, Power line, COMmon line	1.25 to 1.65 mm <sup>2</sup>
Resolver input connector	Use the appropriate 3F88L-CR type cable.

# 1-3-2 Resolver Wiring

The Resolver cable carries low voltage signals. The following precautions should be taken to avoid errors due to noise. When laying cable in a duct, keep the Resolver cable as far away from control and power lines as possible.

Outside of ducts, keep the Resolver cable separate from power lines and other lines, and shield the cable with a grounded metal plate.

If an extension cable is needed in order to connect the Resolver to the Cam Positioner, use only a 3F88L-CRXXXC cable as shown below.

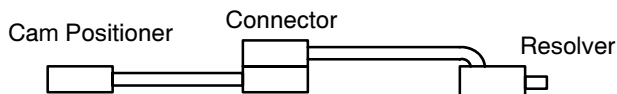

Extension cable: 3F88L-CRXXXC

Cable length is shown in meters.

There are four models of Resolver, and three cables for connecting these Resolvers to the Cam Positioner.

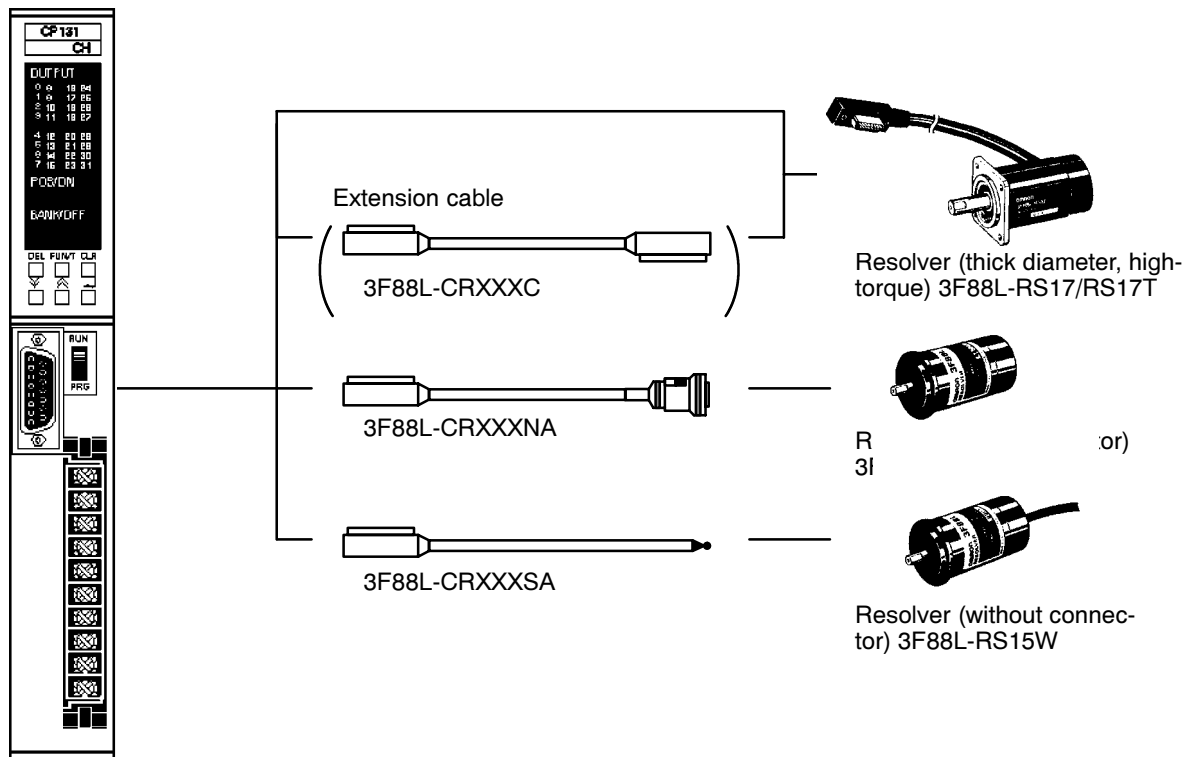

The connector on the front panel of the Cam Positioner is a 15-pin sub-D connector. The pinout is shown in the figure below.

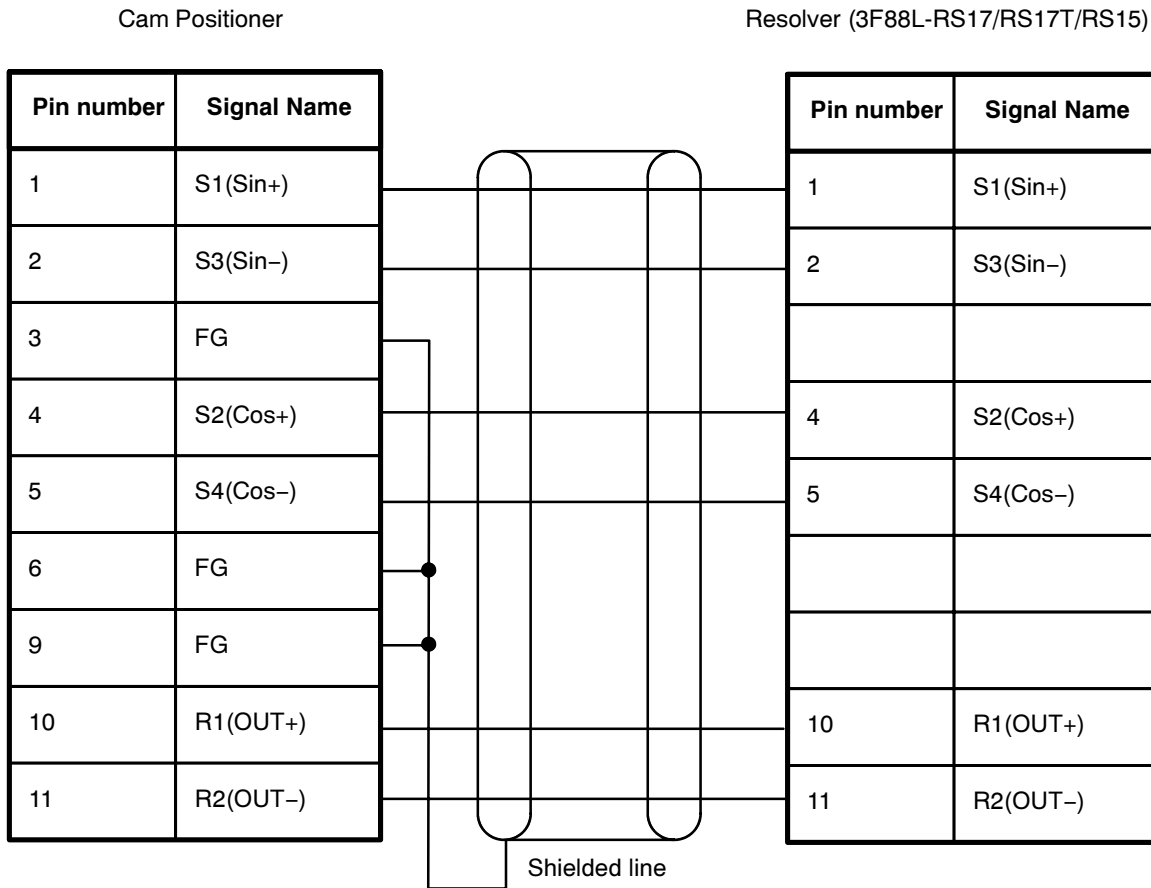

Use Resolver connecting cable 3F88L-CRXXXSA to connect the 3F88L-RS15W Resolver. The following table shows the color coding of the cable.

Color	Signal
Red	S1 (Sin+)
Black	S3 (Sin-)
Yellow	S2 (Cos+)
Blue	S4 (Cos-)
Red/White	R1 (OUT+)
Yellow/White	R2 (OUT-)



**Note** The cable length between the Cam Positioner and the Resolver should not exceed 100 m. If it does, errors may occur.

### 1-3-3 Cam Positioner Wiring

Eight external outputs are provided (points 0 through 7).

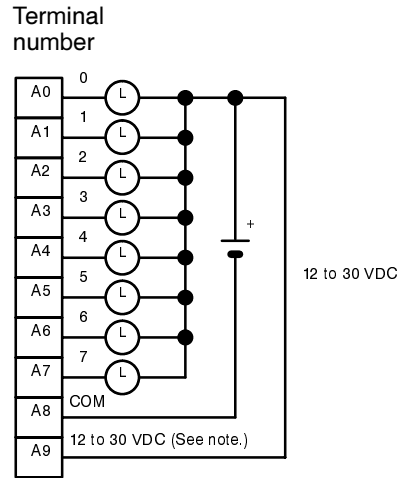

**Note** Be sure not to omit the power supply connection to the DC terminal (A9).

Be sure to use separate cables for the Cam Positioner I/O lines and any other control lines. If the cables run in parallel, keep the distance between the cables to a minimum of 300 millimeters. When housing other cables in the same duct as the Cam Positioner cables, be sure to shield the cables using a grounded metal (iron) plate.

Use the figure below as a guide when wiring the Cam Positioner cables along with other control or power cables.

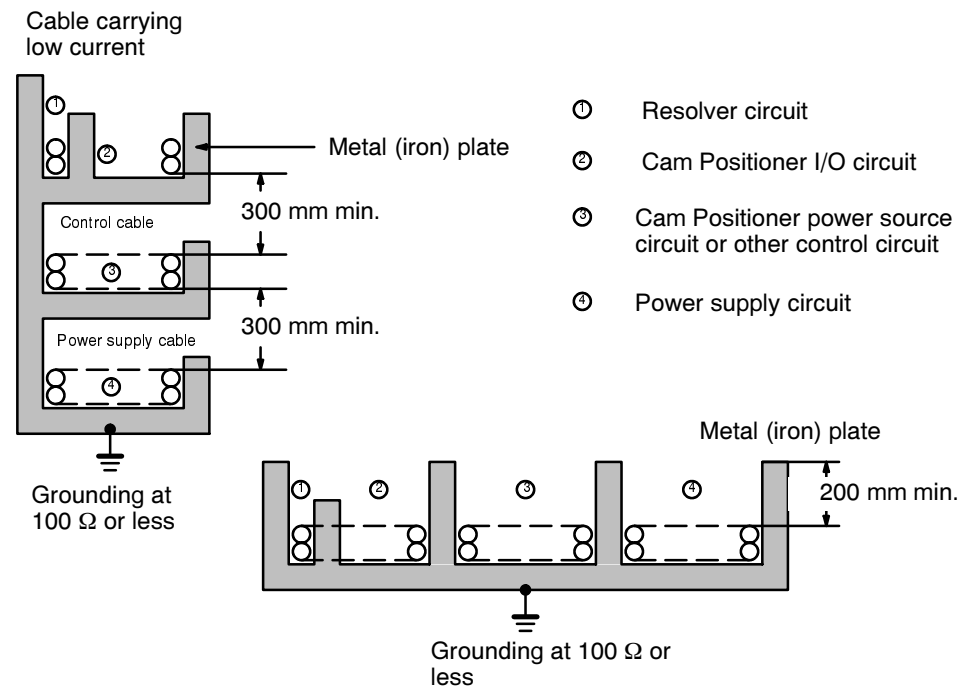

## 1-3-4 Coupling Connection

Connect the Resolver shaft to the shaft of the mechanical system using the coupling provided (model F88L-RL6/RL10). Make sure not to exceed the specifications of the coupling (refer to Appendix A Specifications).

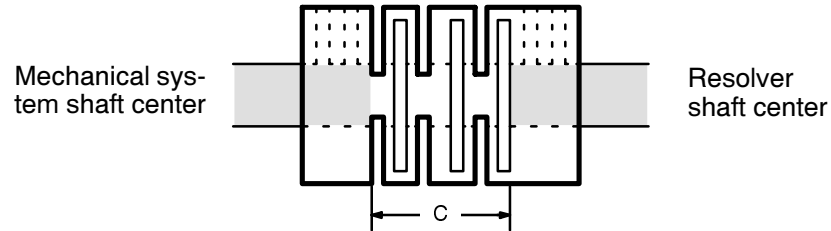

**Caution** Be sure that the shaft center does not protrude into the section labelled "C" above. If the shaft center protrudes into C while rotating, the coupling function will not operate correctly and damage to the equipment may result. If the shaft of the mechanical system is bent or misaligned, the coupling action will be affected, and the Resolver may be damaged.



# SECTION 2

## Functions

2-1	Overview of Functions .....	12
2-2	Implementation .....	13
2-2-1	Switch Settings .....	13
2-2-2	Operation .....	15
2-2-3	Key Sequences .....	21
2-3	Programming .....	36
2-3-1	Two-Word Mode .....	37
2-3-2	Four-Word Mode .....	41

## Section Overview

This section provides a detailed description of the functions of the Cam Positioner. Instructions on how to use these functions are given in table form. Programming instructions are also included.

### 2-1 Overview of Functions

The Cam Positioner settings are made using the keys on the front panel of the Cam Positioner. Modifications can be made easily, thereby shortening the time required for adjustment. In addition, data for the Cam Positioner can be prepared and corrected via the CPU. Data transfer between the Cam Positioner and CPU can be achieved using the SAVE and LOAD instructions in the PC program. However, Cam data may be input directly via the keys on the front panel of the Cam Positioner. All data is kept in EEPROM, so battery back-up is not required. The Cam Positioner can be set to turn ON and OFF as many as 180 times ( $1^\circ$  resolution) or 360 times ( $0.5^\circ$  resolution) per revolution at each output. ON and OFF data can be set by actually moving the mechanical system, using a special teaching function. If the origin of the mechanical system is different from Resolver origin, origin alignment can easily be executed electronically. Cam Positioner data input can be inhibited by key operation or via the DIP switch on the back panel of the Cam Positioner.

## 2-2 Implementation

Before the Cam Positioner can be operated, certain operations must be correctly performed. This section provides details on how to perform these functions. Be sure to perform all settings according to the way you have your System configured.

### 2-2-1 Switch Settings

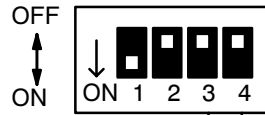

Word mode setting

4	Function
0	Two-word mode
1	Four-word mode setting

Resolution setting

3	Function
0	360 steps with 1° resolution
1	720 steps with 0.5° resolution

The Cam Positioner operates the same way as a mechanical sequencer. Cam Positioner data can be saved in RAM by using the keys on the front panel or via the CPU. When the Cam Positioner mode is set to RUN, the cam data in RAM is automatically transferred to EEPROM. Operations are then based on the transferred data.

### Examples

#### With 360 Steps

Output	ON angle	OFF angle
1	90	200
2	45	72
2	110	180
2	230	325
3	120	30

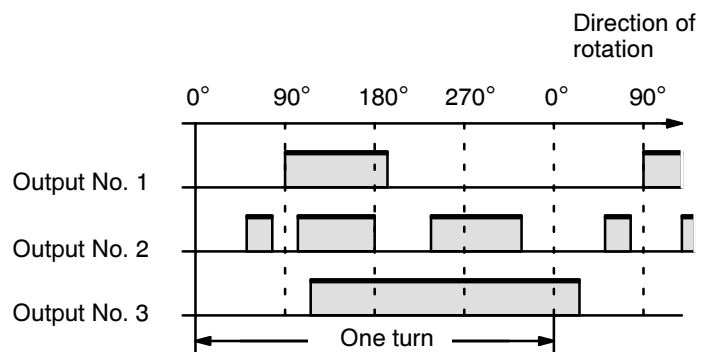

For output 1, OFF up to 89°; ON from 90° to 199°.

With 720 Steps

Output	ON angle	OFF angle
1	180	420
2	90	360
2	540	650
3	240	180

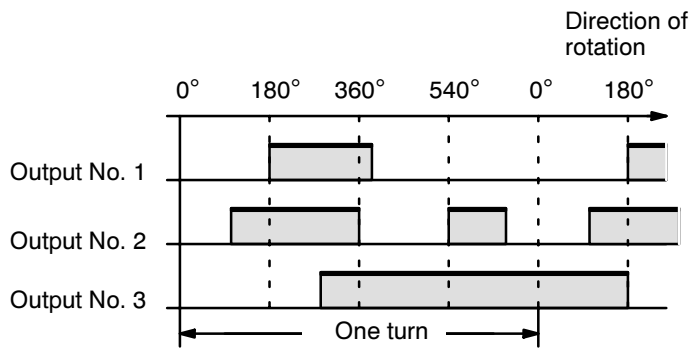

For output 1, OFF up to 179°; ON from 180° to 419°.

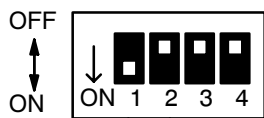

Direction of rotation (See note.)

2	Function
0	Clockwise rotation of the Resolver shaft increases the angle.
1	Counterclockwise rotation of the Resolver shaft increases the angle.

Key disable

1	Function
0	Operation keys and mode selector are enabled.
1	Operation keys and mode selector are disabled.

Note

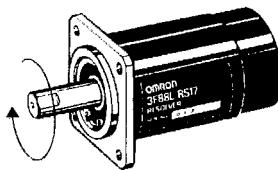

Resolver increase the angle, set pin 2 to OFF.

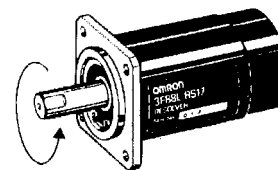

of the Resolver increase the angle, set pin 2 to ON.

## 2-2-2 Operation

The Cam Positioner has two operating modes: PRG (PRoGram) and RUN. The functions of each mode are described below.

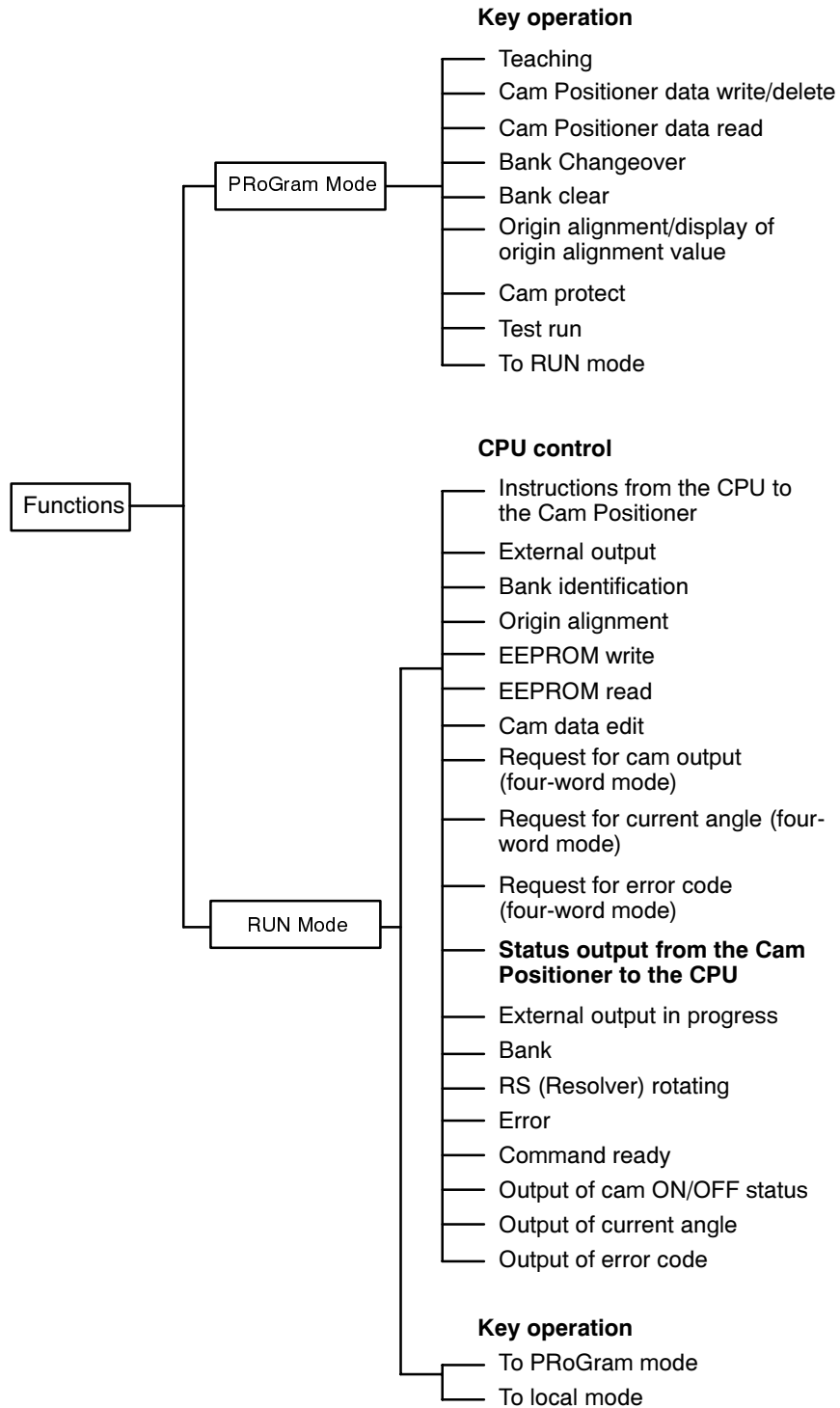

### Data Configuration

The Cam Positioner can be used with the C500, C1000H, and C2000H PCs. The specific word settings and instructions vary according to the model of CPU and the Rack to which the Cam Positioner is mounted. One mode uses the intelligent I/O



functions and the other does not. (Refer to Section 2-3 Programming to determine which mode you should use.)

The intelligent I/O functions (FUNction 87/88) transfer a maximum of 255 words of data between the Cam Positioner and CPU at once. MOV (FUNction 21) transfers data one word at a time. I/O refresh is executed each time an intelligent I/O function is executed, but MOV (FUNction 21) refreshes the I/O in accordance with the CPU's scan.

Set the word mode with the DIP switch on the back of the Cam Positioner. For details, refer to Section 2-2-1 Switch Settings on page 13.

**Bit Allocation**  
**Two-Word Mode**

Bit	Word n	Word (n+1)
	Out	In
00	PC busy *	Cam busy *
01	PC write completed *	Cam read completed *
02	PC read completed *	Cam write completed *
03	External output permission	External output in progress
04	Bank designation	Bank
05	Origin alignment	Resolver rotating
06	EEPROM write	Error
07	EEPROM read	Instruction ready
08	Not used	
09		
10		
11		
12		
13		
14		
15		

\* Bits marked with an asterisk are used as system flags by the intelligent I/O functions. Bits in sections that are not used should be set to 0. The letter n indicates the address of the first word allocated to the Cam Positioner for data transfer.

Four-Word Mode

Bit	Word n	Word n+1	Word n+2	Word n+3
	Out	Out	In	In
00	CPU to Cam Positioner data bus		Cam Positioner to CPU data bus	
01				
02				
03		External output permission		External output in progress
04		Bank designation		Bank
05		Origin alignment		Resolver rotating
06		EEPROM write		Error
07		EEPROM read		Instruction ready
08				
09		Cam data write		
10		Cam delete		
11		Current angle transmission request		Current angle transfer in progress
12		Output 1 transmission request		Output 1 transfer in progress
13		Output 2 transmission request		Output 2 transfer in progress
14		Error code transmission request		Error code transfer in progress
15		PC acknowledge		Cam Positioner acknowledge

Bits marked "Not used" cannot be modified by the user. The letter n indicates the address of the first word allocated to the Cam Positioner for data transfer.

### Instruction Bit Functions

#### Command

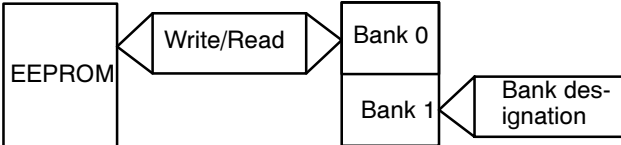
Bit name	Usable setting		Functions
	Two-word mode	Four-word mode	
External output inhibit	Yes	Yes	Enables or disables external outputs. ON: Enable OFF: Disable
Bank designation	Yes	Yes	Specifies the bank. ON: bank 1 OFF: bank 0
Origin alignment	Yes	Yes	Sets the current angle to 0. This instruction will work only when the Resolver is stopped (resolver rotating = 0).
EEPROM write	Yes	Yes	Writes Cam data from the work memory to the EEPROM. The data will be written only to the unspecified (inactive) bank.
EEPROM read	Yes	Yes	<p>Reads Cam data from the EEPROM into the work memory. The data will be read only from the unspecified bank.</p>  <p>When the bank 1 is specified, data will be written to only bank 0.</p>
Cam data write	No	Yes	Transfers Cam data from the CPU via the Cam Positioner data bus to the work memory.
Cam data delete	No	Yes	Deletes all steps or a single piece of Cam data within the same output.
Request for current angle	No	Yes	Sends the current angle to the CPU.
Output 1 transmission request	No	Yes	Sends the ON/OFF status of output 1 (bits 0 through 15) to the CPU.
Output 2 transmission request	No	Yes	Sends the ON/OFF status of output 2 (bits 16 through 31) to the CPU.
Error code transmission request	No	Yes	When an error occurs, the CPU reads the error code.
PC acknowledge	No	Yes	When data is transferred between the CPU and Cam Positioner, the CPU acknowledges that the data was received via this bit.

Writing of cam data to the work memory, and writing data to or reading data from EEPROM (as well as all transfers involving the CPU) can only be made using the unspecified (inactive) bank. This ensures that the data in use cannot be directly accessed.

Status

Bit name	Mode		Functions
	Two-word mode	Four-word mode	
External output in progress	Yes	Yes	ON when the output is enabled.
Bank	Yes	Yes	Shows which bank is currently specified (active). ON: bank 1 OFF: bank 0
Resolver rotating	Yes	Yes	ON when Resolver is rotating; OFF when rotating at 2 rpm or less
Error	Yes	Yes	Turned ON when an error occurs (Refer to Section 3 Troubleshooting for details on errors.)
Instruction ready	Yes	Yes	ON when instructions from the PC can be accepted. OFF under the following conditions.  (1) While the Cam Positioner is set to PPRoGram mode. (2) During the internal initialization shortly after power is supplied. (3) If the watchdog timer malfunctions. (4) While data is being read from or written to the EEPROM. (5) While an instruction from the PC is being executed.
Current angle transfer in progress	No	Yes	ON when the current angle is output to the data bus.
Output 1 transfer in progress	No	Yes	ON while the ON/OFF condition of output 1 (bits 0 through 15) is being output to the data bus.
Output 2 transfer in progress	No	Yes	ON while the ON/OFF condition of output 2 (bits 16 through 31) is being output to the data bus.
Error code transfer in progress	No	Yes	ON while an error code is being output to the data bus.
Cam Positioner acknowledgement	No	Yes	The CPU receives a signal that the instruction is sent to the Cam Positioner completed execution normally.

Any time data is transferred between the CPU and Cam Positioner, be sure to have the program use the instruction ready command (to verify that the instruction completed execution normally) before attempting to execute the next instruction. When an EEPROM read or write command is executed, the instruction ready flag does not turn ON until the writing is complete. In general, the larger the amount of data that is being written, the more time it will take to transfer.

**Data Transfer**

In order to achieve data transfer between the CPU and Cam Positioner, the correct instructions must appear in the PC program, and appropriate data must be written to the Cam Positioner.

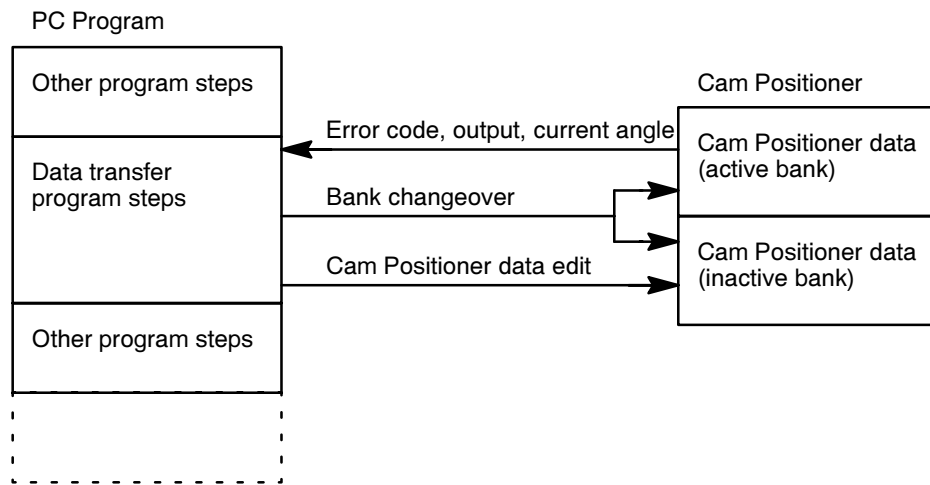

## 2-2-3 Key Sequences

Key sequences are divided into those used in RUN mode and those used in PProGram mode. The six keys shown below are used. The boxes labeled POS/ON and BANK/OFF on the front panel of the Cam Positioner display information depending on whether the Cam Positioner is in RUN mode or PProGram mode. RUN mode lets the Cam Positioner be used in its special local mode (refer to Section 2-2-3 RUN Mode on page 22 ). PProGram mode lets Cam Positioner data be modified, and enter teach mode to be programmed manually. PProGram mode also permits the following five operations: bank clearing, bank changeover, display of origin alignment value (and origin alignment), cam protect, and test run.

### Status Display

POS/ON



RUN mode: Displays the current angle.

PProGram mode: Displays the bank or the ON angle of the Cam Positioner data.

BANK/OFF



RUN mode: Displays the bank number being executed.

PProGram mode: Displays the output point or the OFF angle of the Cam Positioner data.

Key	Functions
	Used for Cam Positioner data deletion, bank clearing, or cancelling of cam protection.
	Used for selecting a FUNction number and for teaching.
	Used for initializing the display.
	Used for output and FUNction number selection, or Cam data input. These keys are used for FUNction number selection and Cam Positioner data input while in RUN mode. Press the up-arrow key to increase the displayed figure. Press the down-arrow key to decrease the displayed figure. If, while holding down one of the keys, you then press the remaining key as well, the figure will increase or decrease, respectively, at a much higher speed.
	Used for setting all input data.
	There are 32 indicators on the front panel of the Cam Positioner that display the ON/OFF status of the cam outputs. When a certain cam output is ON, the corresponding display is lit; when the cam output is OFF, the corresponding display is unlit. When cam protect (FUNCTION 13) is executed, the displays corresponding to protected cam outputs are lit. During modification of cam data, the displays corresponding to the specified cam outputs are lit.

## Functions

FUNction number	Function
FUNction 11	Bank clearing Bank changeover
FUNction 12	Origin alignment
FUNction 13	Cam protect
FUNction 14	Test Run/Adjustment
FUNction 21	To local mode
FUNction 31	To PProGram mode

**Note** The Cam Positioner functions are completely independent of the CPU functions.

## RUN Mode

When the RUN/PProGram selector is set to RUN, the Cam Positioner enters RUN mode. The display will be as follows.

POS/ON

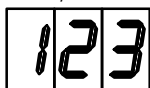

Indicates the current angle (0° to 359° or 0° to 719° )

BANK/OFF

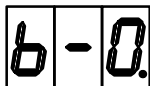

Indicates the active bank. The numeral six is the code for BANK; in this case, the display indicates bank 0.

When external output is permitted, the decimal point to the lower right of the bank number is lit. When the Cam Positioner is in local mode, the decimal point flashes.









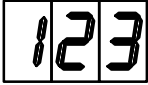
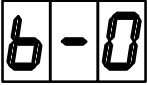

The ON/OFF status of outputs 0° to 31° are shown on the LED display at the upper part of the front panel.

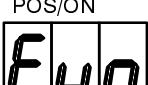
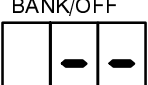
### Local Mode

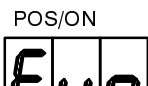
Local mode can be used only when the PC is in RUN mode. In local mode, the Cam Positioner functions independent of the PC. In this mode, outputs cannot be disabled. Local mode provides the following functions:

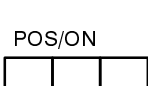

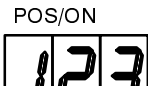
Function	Local mode
Modifications of Cam Positioner data by CPU.	Yes
Bank specification by CPU.	No
Origin alignment by CPU.	No
Output disable by PC	No
Output of ON/OFF status to CPU	Yes
Output of current angle to CPU	Yes
Output of error code to CPU	Yes

### To Enter Local Mode

Key Operation	Display	Explanation
	POS/ON      BANK/OFF  	RUN mode display
↓  	POS/ON      BANK/OFF  	Set the FUNCTION number using the up-arrow and down-arrow keys.
↓ 	POS/ON      BANK/OFF  	Select FUNCTION 21.
↓ 	POS/ON      BANK/OFF  	When you change to local mode, "run on" is displayed. To return to RUN mode, repeat the above sequence, and "run off" will be displayed.
↓ 	POS/ON      BANK/OFF  	Local mode display. The decimal point to the lower right of the bank number flashes.



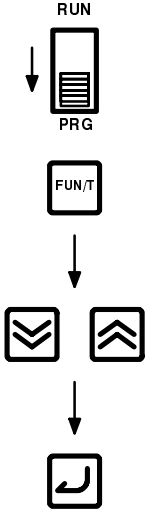

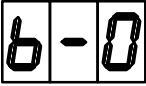
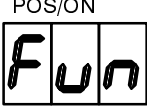
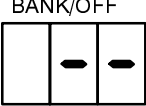
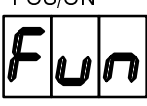
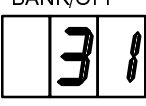
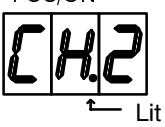
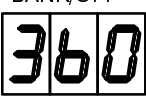
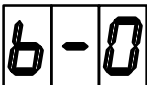
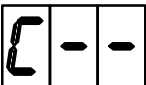





To Enter Program Mode

Key Operation	Display	Explanation
	<p>POS/ON      BANK/OFF</p> <p>      </p> <p>POS/ON      BANK/OFF</p> <p>      </p> <p>POS/ON      BANK/OFF</p> <p>      </p> <p>POS/ON      BANK/OFF</p> <p>      </p> <p>POS/ON      BANK/OFF</p> <p>      </p>	<p>RUN mode display (When in local mode, the decimal point to the lower right of the bank number flashes.)</p> <p>Select FUNction 31.</p> <p>The word mode and number of steps are displayed for about one second (The example display indicates two-word mode with 360 steps.)</p> <p>PRoGram mode initial display</p>











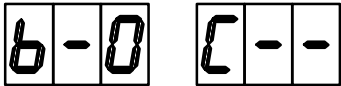



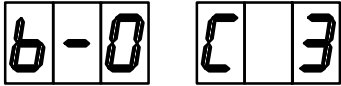











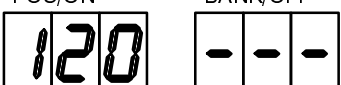



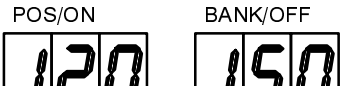

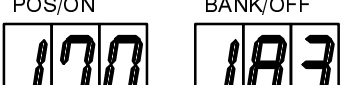

**Note** Setting the RUN/PRoGram selector to PRoGram and turning the power OFF and then back ON again will also put the Cam Positioner in PRoGram mode.

**PRoGram Mode**

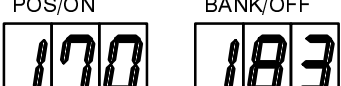
**Cam Positioner Data Read**

Key Operation	Display	Explanation
	POS/ON      BANK/OFF 6-0      C--	PRoGram mode initial display
	POS/ON      BANK/OFF 6-0      C15	Select output 15 using the up-arrow and down-arrow keys.
	POS/ON      BANK/OFF 0      25	The ON and OFF angles of the first step of output 15 are displayed.
	POS/ON      BANK/OFF 100      150	The ON and OFF angles of following step of output 15 are displayed.
	POS/ON      BANK/OFF 6-0      C15	Returns to the same state as when output 15 was first selected.
	POS/ON      BANK/OFF 6-0      C20	Select output 20.
	POS/ON      BANK/OFF 112      154	The ON and OFF angles of the first step of output 20 are displayed.
	POS/ON      BANK/OFF - - -      - - -	No data is registered from the next step.
	POS/ON      BANK/OFF 6-0      C20	Returns to the same state as when output 20 was first selected.
	POS/ON      BANK/OFF 6-0      C--	Returns to the PRoGram mode initial display.

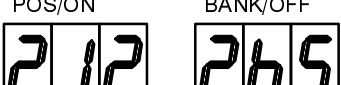
### Cam Positioner Data Modification

Key Operation	Display	Explanation
	POS/ON      BANK/OFF 	<b>WRITE</b> PProGram mode initial display
		
		
	POS/ON      BANK/OFF 	Select output 3.
		
		
	POS/ON      BANK/OFF 	The existing data is displayed. If no data has been previously written to the output concerned, "----" is displayed.
		
		
	POS/ON      BANK/OFF 	Use the up-arrow and down-arrow keys to set the ON angle.
		
		
	POS/ON      BANK/OFF 	The ON angle has been specified, and the Cam Positioner is waiting for the OFF angle to be specified.
		
		
	POS/ON      BANK/OFF 	Specify the OFF angle.
		
		
	POS/ON      BANK/OFF 	The data ON angle = 120° and OFF angle = 150° is registered, and the data for the next step is displayed.
		
		
	POS/ON      BANK/OFF 	<b>DELETE</b> Delete the data ON angle = 170° and OFF angle = 183°, and the data for the next step is displayed.
		
		
	POS/ON      BANK/OFF 	The data ON angle = 170° and OFF angle = 183° is deleted, and the data for the next step data is displayed.
		













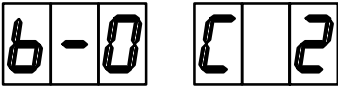

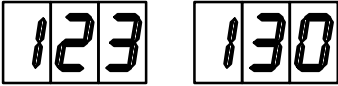

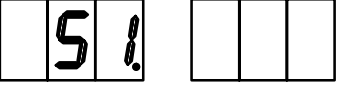

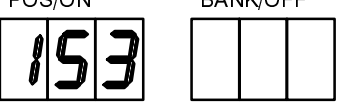

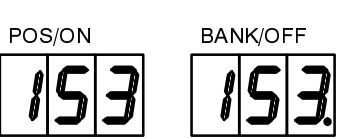
Cam Positioner Data Modification (cont.)

Key Operation	Display	Explanation
 <p>DEL ↓ [Enter] ↓ CLR ↓ CLR</p>	<p>POS/ON                      BANK/OFF</p> <p>212                              265</p> <p>Flashing                      Flashing</p> <p>POS/ON                      BANK/OFF</p> <p>270                              300</p> <p>POS/ON                      BANK/OFF</p> <p>6-0                              [ 3</p> <p>POS/ON                      BANK/OFF</p> <p>6-0                              [ - -</p>	<p>Delete this data as well.</p> <p>Data ON angle = 212° and OFF angle = 265° is deleted, and the data for the next step data is displayed.</p> <p>Returns to the same state as when output 3 was selected.</p> <p>Returns to the PProGram mode initial display.</p>

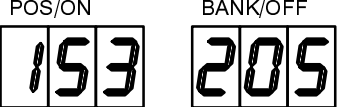
When more than one step value has been specified for one output, the data will be read according to size, starting with the lowest value and moving to the largest value.

Teaching

After a mechanical system has been coupled to the Resolver, cam data can be registered by physically moving the mechanical system.

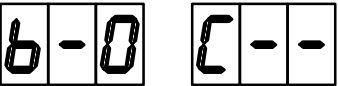









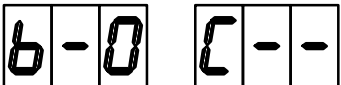

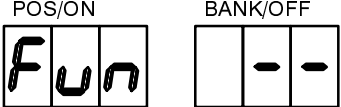

Key Operation	Display	Explanation
	POS/ON      BANK/OFF 	PProGram mode initial display
	POS/ON      BANK/OFF 	Select output 2.
	POS/ON      BANK/OFF 	The existing data is displayed. If no data has been previously written to the output concerned, "----" is displayed.
	POS/ON      BANK/OFF 	Displays the current angle, and waits for teaching of the ON angle. The decimal point to the lower right of the final digit is flashes.
Movement of mechanical system 	POS/ON      BANK/OFF 	Move the mechanical system. Upon reaching the angle that should be specified as the ON angle, press ENTER.
	POS/ON      BANK/OFF 	Displays the current angle, and waits for teaching of the OFF angle. The decimal point to the lower right of the final digit is flashes.
	POS/ON      BANK/OFF 	Move the mechanical system. Upon reaching the angle that should be specified as the OFF angle, press ENTER.
Movement of mechanical system 	POS/ON      BANK/OFF 	Move the mechanical system. Upon reaching the angle that should be specified as the OFF angle, press ENTER.
	POS/ON      BANK/OFF 	Move the mechanical system. Upon reaching the angle that should be specified as the OFF angle, press ENTER.
	POS/ON      BANK/OFF 	Returns to the same state as when output 2 was selected.
 	POS/ON      BANK/OFF 	Returns to the PProGram mode initial display.

Use the FUNction key for the following 5 operations.

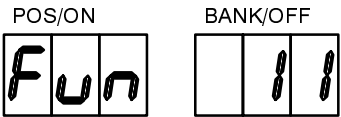
Function	Number	Description
Bank changeover Bank clear	11	Allows the active bank to be changed over and the inactive bank to be cleared.
Origin alignment	12	Registers the current angle as the origin.
Cam protect	13	Protects all cam data from modification.
Test run	14	Displays the current angle and turns ON all output indicators.

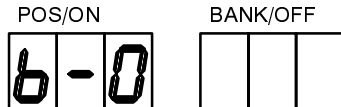
Bank Clear:

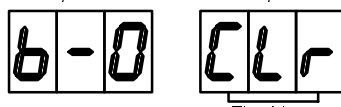
Before executing bank clear, make sure that no cam are protected. If you attempt to clear a bank that contains protected cams, a protect error (E22) will occur.

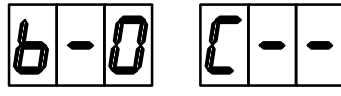
Key Operation	Display	Explanation
	POS/ON      BANK/OFF 	PProGram mode initial display
		
		
		
		
	POS/ON      BANK/OFF 	
		
	POS/ON      BANK/OFF 	Select FUNction 11.
		
	POS/ON      BANK/OFF 	Now, bank 0 is selected.
		
	POS/ON      BANK/OFF 	Clear all cam data in bank 0.
		
	POS/ON      BANK/OFF 	Returns to the PProGram mode initial display.

Bank Changeover:











Key Operation	Display	Explanation
	<p>POS/ON      BANK/OFF</p> <p>b-0      [ - -</p>	<p>PProGram mode initial display</p>
	<p>POS/ON      BANK/OFF</p> <p>Fun      - -</p>	
	<p>POS/ON      BANK/OFF</p> <p>Fun         </p>	<p>Select FUNction 11.</p>
	<p>POS/ON      BANK/OFF</p> <p>b-0         </p>	<p>Now, bank 0 is selected.</p>
	<p>POS/ON      BANK/OFF</p> <p>b-1         </p>	<p>Select bank 1 using the up-arrow and down-arrow keys.</p>
	<p>POS/ON      BANK/OFF</p> <p>b-1      [ - -</p>	<p>Changeover completed. Returns to the PProGram mode initial display.</p>











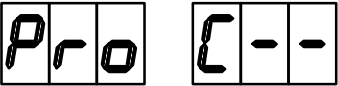

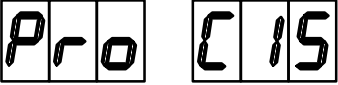

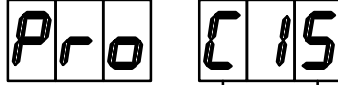

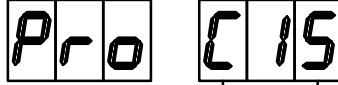
Origin Alignment:

Key Operation	Display	Explanation
	<p>POS/ON      BANK/OFF</p> <p>b-0      [- -]</p>	<p><b>Display of origin alignment value</b></p> <p>PProGram mode initial display</p>
	<p>POS/ON      BANK/OFF</p> <p>Fun      - -</p>	
	<p>POS/ON      BANK/OFF</p> <p>Fun      12</p>	<p>Select FUNction 12.</p>
	<p>POS/ON      BANK/OFF</p> <p>AdJ      123</p>	<p>Displays the current origin alignment value.</p>
	<p>POS/ON      BANK/OFF</p> <p>Fun      - -</p>	<p><b>Origin alignment</b></p>
	<p>POS/ON      BANK/OFF</p> <p>Fun      12</p>	<p>Select FUNction 12.</p>
	<p>POS/ON      BANK/OFF</p> <p>AdJ      123</p>	<p>Displays the current origin alignment value.</p>
	<p>POS/ON      BANK/OFF</p> <p>AdJ      215</p>	<p>Execute origin alignment and set the current position to "0". The new origin alignment value is displayed.</p>
	<p>POS/ON      BANK/OFF</p> <p>b-0      [- -]</p>	<p>Returns to the PProGram mode initial display after about one second.</p>

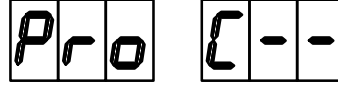

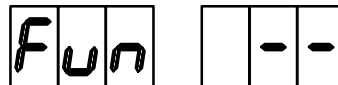
Cam Protect:



Key Operation	Display	Explanation
	POS/ON      BANK/OFF b-0      C--	<b>Cam protect</b> PProGram mode initial display
	POS/ON      BANK/OFF Fun      --	
 	POS/ON      BANK/OFF Fun      13	Select FUNction 13.
	POS/ON      BANK/OFF Pro      C--	Ready to accept the number of the cam to be protected. The indicator corresponding to the protected cam is lit.
 	POS/ON      BANK/OFF Pro      C15	Protect output 15.
	POS/ON      BANK/OFF Pro      C16	Protection is completed. The display corresponding to output 15 is lit and the next output number is displayed on the BANK/OFF display.
	POS/ON      BANK/OFF Pro      C--	
	POS/ON      BANK/OFF Fun      --	
 	POS/ON      BANK/OFF Fun      13	<b>Cancelling cam protect</b> Select FUNction 13.

Key Operation	Display	Explanation
	POS/ON      BANK/OFF 	Ready to accept the number of the cam to be un-protected. The indicator corresponding to the protected cam is lit.
 	POS/ON      BANK/OFF 	Cancel cam protection for output 15.
	POS/ON      BANK/OFF 	Press the DELeTe key. The output number display is flashing and waiting for cancelling.
 	POS/ON      BANK/OFF  <p style="text-align: center;">Flashing</p>	Output 15 is cancelled.
	POS/ON      BANK/OFF 	Ready to receive an output number
 	POS/ON      BANK/OFF 	Ready to receive an output number
 	POS/ON      BANK/OFF 	Ready to receive an output number
 	POS/ON      BANK/OFF 	Returns to the PProGram mode initial display.

Test Run:

During operation, the test run initial display shows the ON/OFF status of the outputs. This lets you verify that the Cam Positioner is operating correctly. If fine adjustment to the ON/OFF angles is needed, the data may be easily changed using the following procedure.

Key Operation	Display	Explanation
	POS/ON      BANK/OFF 6-0      C--	PProGram mode initial display
	POS/ON      BANK/OFF Fun      --	
	POS/ON      BANK/OFF Fun      14	Select FUNction 14.
	POS/ON      BANK/OFF 153      14	Displays the current angle and "PCH" (Program teaCHing).
	POS/ON      BANK/OFF 10      25	The ON angle display is flashing, indicating that the ON angle is ready to be adjusted.
	POS/ON      BANK/OFF 7      25	The ON angle is specified as "7".
	POS/ON      BANK/OFF 7      25	The ON angle has been set. Now the OFF angle display is flashing, and waiting for an OFF angle to be specified.
	POS/ON      BANK/OFF 7      23	The OFF angle is specified as "23".
	POS/ON      BANK/OFF 36      41	The OFF angle is set. Now the next data for the same cam is displayed.

Key Operation	Display	Explanation																		
 ↓  ↓ 	<p>POS/ON      BANK/OFF</p> <table border="1" style="width: 100%; text-align: center;"> <tr> <td style="width: 30px;">-</td> <td style="width: 30px;">-</td> <td style="width: 30px;">-</td> <td style="width: 30px;">-</td> <td style="width: 30px;">-</td> <td style="width: 30px;">-</td> </tr> </table> <p>POS/ON      BANK/OFF</p> <table border="1" style="width: 100%; text-align: center;"> <tr> <td style="width: 30px;">1</td> <td style="width: 30px;">5</td> <td style="width: 30px;">3</td> <td style="width: 30px;">P</td> <td style="width: 30px;">C</td> <td style="width: 30px;">H</td> </tr> </table> <p>POS/ON      BANK/OFF</p> <table border="1" style="width: 100%; text-align: center;"> <tr> <td style="width: 30px;">6</td> <td style="width: 30px;">-</td> <td style="width: 30px;">0</td> <td style="width: 30px;">[</td> <td style="width: 30px;">-</td> <td style="width: 30px;">-</td> </tr> </table>	-	-	-	-	-	-	1	5	3	P	C	H	6	-	0	[	-	-	<p>If no further cam data exists, “- - - - -” is displayed.</p> <p>Returns to the test run mode initial display.</p> <p>Returns to the PProGram mode initial display.</p>
-	-	-	-	-	-															
1	5	3	P	C	H															
6	-	0	[	-	-															

**To Enter RUN Mode**

Key Operation	Display	Explanation																		
	<p>POS/ON      BANK/OFF</p> <table border="1" style="width: 100%; text-align: center;"> <tr> <td style="width: 30px;">6</td> <td style="width: 30px;">-</td> <td style="width: 30px;">0</td> <td style="width: 30px;">[</td> <td style="width: 30px;">-</td> <td style="width: 30px;">-</td> </tr> </table> <p>POS/ON      BANK/OFF</p> <table border="1" style="width: 100%; text-align: center;"> <tr> <td style="width: 30px;">0</td> <td style="width: 30px;">0</td> <td style="width: 30px;">0</td> <td style="width: 30px;">0</td> <td style="width: 30px;">0</td> <td style="width: 30px;">0</td> </tr> </table> <p style="text-align: center;">Flashing      Flashing</p> <p>POS/ON      BANK/OFF</p> <table border="1" style="width: 100%; text-align: center;"> <tr> <td style="width: 30px;">1</td> <td style="width: 30px;">2</td> <td style="width: 30px;">3</td> <td style="width: 30px;">6</td> <td style="width: 30px;">-</td> <td style="width: 30px;">0</td> </tr> </table>	6	-	0	[	-	-	0	0	0	0	0	0	1	2	3	6	-	0	<p>You must move to the PProGram mode initial display before you can change to RUN mode.</p> <p>Turn the RUN/PProGram selector to RUN, and the display to the left begins to flash. During this time, the data in the work memory is being written to the EEPROM.</p> <p>Changes to RUN mode after approximately one second.</p>
6	-	0	[	-	-															
0	0	0	0	0	0															
1	2	3	6	-	0															

## 2-3 Programming

There are two ways of programming the Cam Positioner: two-word mode and four-word mode. If your PC supports the intelligent I/O functions and the Cam Positioner is not mounted to a Remote I/O Slave Rack use two-word mode. Use four-word mode otherwise.

In two-word mode, the intelligent I/O functions directly read data from and directly write data to the Cam Positioner. In four-word mode, use OUT and MOV to transfer data. (For details regarding any of these functions, refer to the Operation Manual for your PC.)

There is an important point to keep in mind when programming the Cam Positioner. When data is written to the Cam Positioner (in either mode) the new data is added to the old data; that is the old data is not automatically deleted. For example, if output 0 is already specified to turn OFF at 0° and ON at 10°, and without deleting this old data, output 0 is specified to turn ON at 100°, and OFF at 200°, the resultant data will be as follows: Output 0: 0° OFF, 10° ON, 100° ON, 200° OFF. If you want to replace some or all of the existing Cam Positioner data, first delete the respective existing data. If you program more than one ON or OFF in succession, a cam ON/OFF value input error will occur.

## 2-3-1 Two-Word Mode

In two-word mode, three words of data are transferred from the CPU to the Cam Positioner as one unit. When a single step is deleted, the angle does not need to be turned OFF. And when all steps are deleted, no ON/OFF angles need to be specified, however set any unneeded data to 0 when transferring. The figure below shows how the data is transferred.

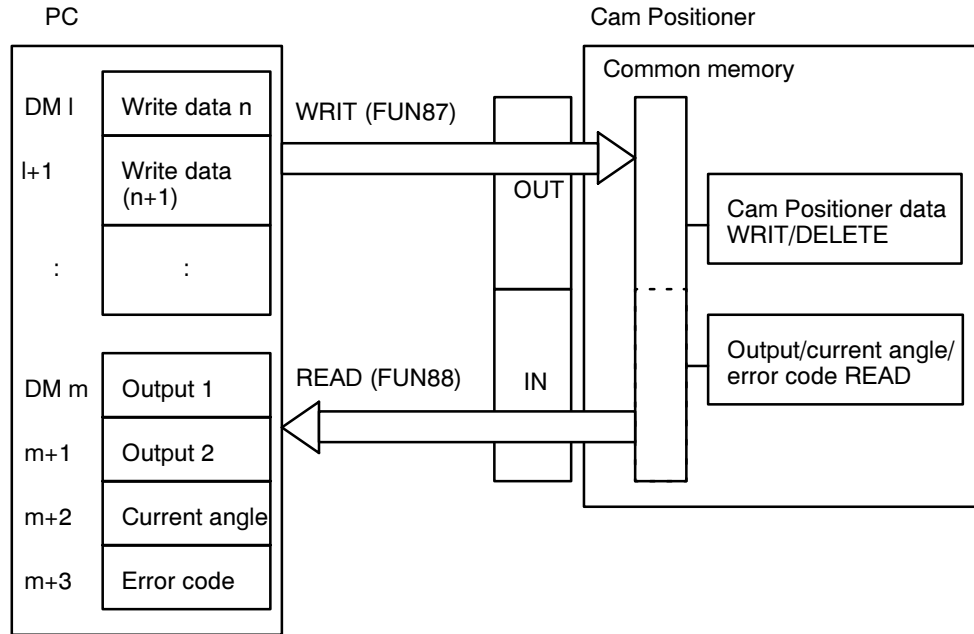

**Note** Data memory is used in the example above, but the IR area can also be used.

### Cam Positioner Data Write/Delete Format (PC to Cam Positioner)

Bit	15 - 12	11 - 8	7 - 4	3 - 0
Word l	Code number		Output number	
	x10	x1	x10	x1
Word l+1	0	ON angle		
		x100	x10	x1
Word l+2	0	OFF angle		
		x100	x10	x1

**Note** The words must be in the DM or IR areas.

Code number	Name	Function
10	Write	Writes data.
20	1 step deletion	Deletes Cam Positioner data specified by the ON angle.
30	All step deletion	Deletes all Cam Positioner data of specified nos.

**Write Programming Example**

In this example the C1000H is used and the Cam Positioner is allocated words 000 and 001. Output 0 is programmed to turn ON from 0 to 9° and 30° to 39°. Output 1 is programmed to turn ON from 50° to 59° and 70° to 79°.

Use a differentiation up (bit B in the program below) as the input to WRIT. When the input ON time of B is 2 scan times or more, and WRIT is executed several times, the same Cam Positioner data is written several times, causing a Cam Positioner data duplication error (E23).

**Data Memory Allocation**

DM address	15 ← → 00				Explanation
0100	1	0	0	0	Write to output 0
0101	0	0	0	0	ON angle = 0°
0102	0	0	1	0	OFF angle = 10°
0103	1	0	0	0	Write to output 0
0104	0	0	3	0	ON angle = 30°
0105	0	0	4	0	OFF angle = 40°
0106	1	0	0	1	Write to output 1
0107	0	0	5	0	ON angle = 50°
0108	0	0	6	0	OFF angle = 60°
0109	1	0	0	1	Write to output 1
0110	0	0	7	0	ON angle = 70°
0111	0	0	8	0	OFF angle = 80°

**Ladder Diagram**

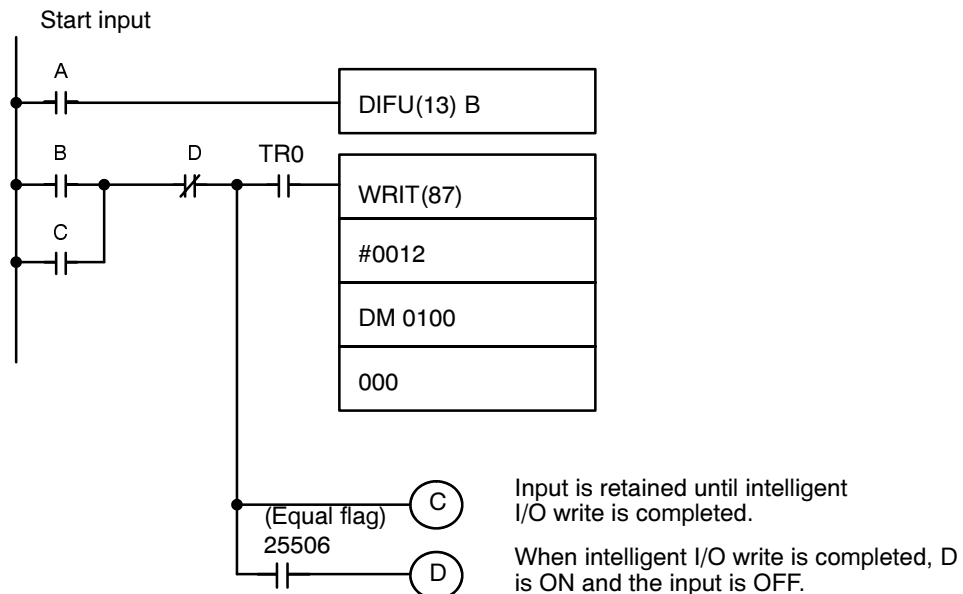

Bits B, C, and D can be any IR bits. This program is capable of handling all step deletion and one step deletion according to the data it receives via the DM area.

**Output/Current Angle/Error Code Read Format (Cam Positioner to CPU)**

Bit	15 - 12	11 - 8	7 - 4	3 - 0
Word m	Outputs 15 through 0 (correspond to each bit)			
Word m+1	Outputs 31 through 16 (correspond to each bit)			
Word m+2	0	Current angle		
		x100	x10	x1
Word m+2	0	x100	Error code	
			x10	x1

**Note** The words must be in the DM or IR areas.



### Read Program Example

In this example, the C1000H is used and the Cam Positioner is allocated words 000 and 001. The program below reads the outputs, current angle, and error codes from the Cam Positioner and stores them in DM 0200 through DM 203.

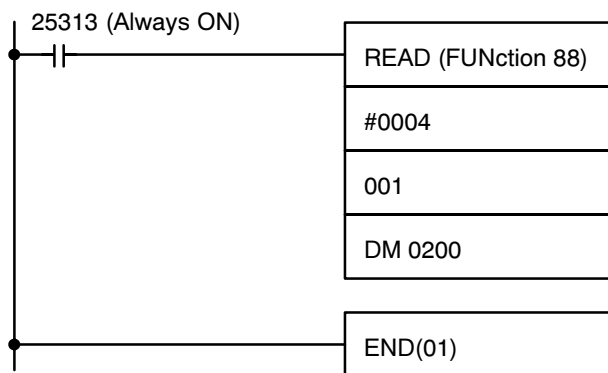

**Note** READ is executed at each scan, and therefore cannot be used at the same time as MOV or OUT. In the program, READ should always be placed immediately before END.

## 2-3-2 Four-Word Mode

Follow the sequence below in order to read and write data in four-word mode.

1,2,3...

1. Output the first word of data to be transferred from the PC to the Cam Positioner data bus.
2. Turn ON bit 9 of word n+1 of the Cam Positioner data.
3. When the write is complete, the Cam Positioner sends Cam Positioner acknowledge (bit 15 of word n+3), which means the instruction has been accepted.
4. According to the instruction being executed, instruction ready (bit 7 of word n+3) turns OFF.
5. After confirming that Cam Positioner acknowledge is ON, turn PC acknowledge (bit 15 of word n+1) ON, and turn Cam Positioner data write OFF.
6. When the process is completed, turn instruction ready (bit 7 of word n+3) ON.

By specifying data write for the second and third words and repeating the above procedure, all Cam Positioner data can be transferred.

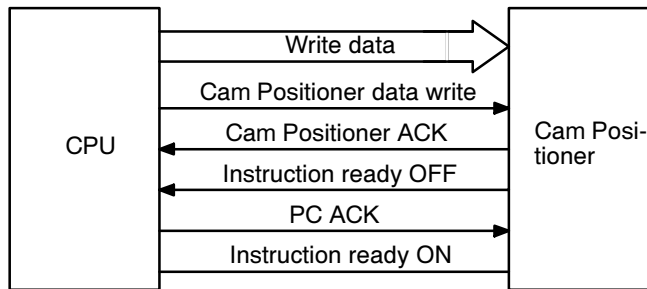

Bit	15 - 12	11 - 8	7 - 4	3 - 0
Word l	1	0	Output number	
			x10	x1
Word l+1	2	ON angle		
		x100	x10	x1
Word l+2	3	OFF angle		
		x100	x10	x1

↑ Data identification number

**Note** The words must be in the DM or IR areas.

**Write Program Example**

In this example, the C1000H is used and the Cam Positioner is allocated words 000 and 001. The program turns output 0 ON from 0° to 9°, and output 1 ON from 30° to 39°.

**Data Memory Allocation**

DM address	15 ← → 00				Explanation
	1	0	0	0	
0100	1	0	0	0	Write to output 0
0101	2	0	0	0	ON angle = 0°
0102	3	0	1	0	OFF angle = 10°
0103	1	0	0	1	Write to output 1
0104	2	0	3	0	ON angle = 30°
0105	3	0	4	0	OFF angle = 40°

### Ladder Diagram

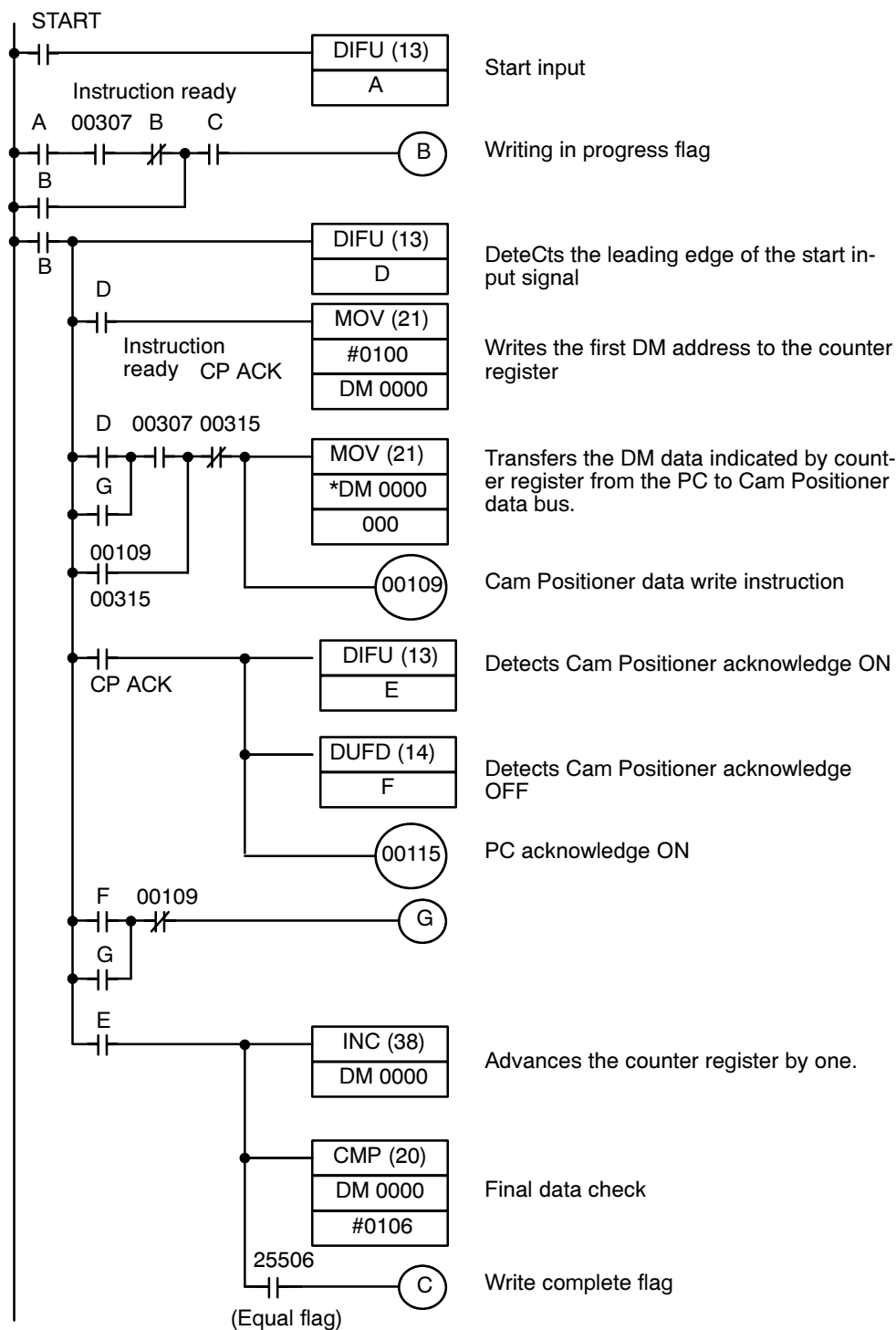

**Note** A, B, C, D, E, and F are IR bits. DM 1000 is used as a counter-register of the word being transferred.

**Cam Positioner Data Deletion**

**Delete Format**

Single step deletion:

Bit	15 - 12	11 - 8	7 - 4	3 - 0
Word I	1	0	Output number	
			x10	x1
Word I+1	2	ON angle		
		x100	x10	x1

↑ Data identification number

All Step Deletion:

Bit	15 - 12	11 - 8	7 - 4	3 - 0
Word I	4	0	Output number	
			x10	x1

↑ Data identification number

**Note** Data memory is used in the above example, but the IR are can also be used.

**Delete Program**

A program for deleting data can be written in the same way as the program for writing data. All that needs to be done is to change the transfer data, and change the instruction from Cam Positioner data write to Cam Positioner data delete.

**Reading of Output and Current Angle**

1,2,3...

1. Turn ON the output 1 read instruction, output 2 read instruction, or current angle read instruction as needed.
2. The Cam Positioner outputs the data corresponding to the instruction to the data bus of the CPU.
3. Upon completion, the Cam Positioner turns Cam Positioner acknowledge (bit 15 of word n+3) ON, which means processing is completed.
4. According to the instruction being executed, instruction ready (bit 7 of word n+3) turns OFF.
5. After confirming that Cam Positioner acknowledge is ON, the CPU turns PC acknowledge (bit 15 of word n+1) ON. Cam Positioner acknowledge then turns the read signal OFF.

6. When the process is complete, instruction ready (bit 7 of word n+3) turns ON.

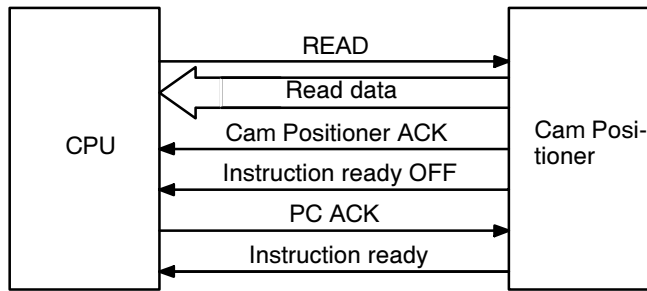

**Read Program Example**

In this example, the C1000H is used and the Cam Positioner is allocated word 000 is allocated to the Cam Positioner. This program reads the present angle via DM 0300.

**Ladder Diagram Program**

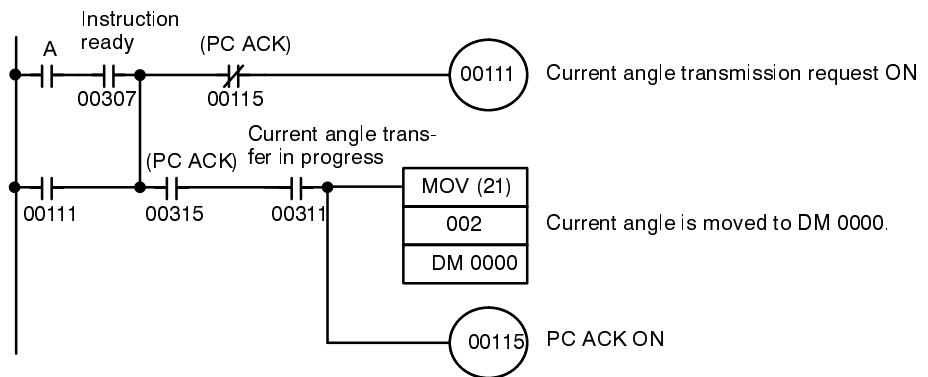



## **SECTION 3**

### **Troubleshooting**

3-1	System Errors .....	48
3-2	Program Errors .....	49
3-3	Communication Errors .....	50
3-4	Error Code Transfer .....	51



## Section Overview

Errors may be divided into the following three types: system errors, program errors, and communication errors. Each of these errors requires a different troubleshooting method. Program errors and Resolver input errors can be cleared by pressing the CLEAR key on the front panel of the Cam Positioner. Communication errors are automatically cleared when the correct instructions or data are sent to the Cam Positioner. The figure below outlines these procedures.

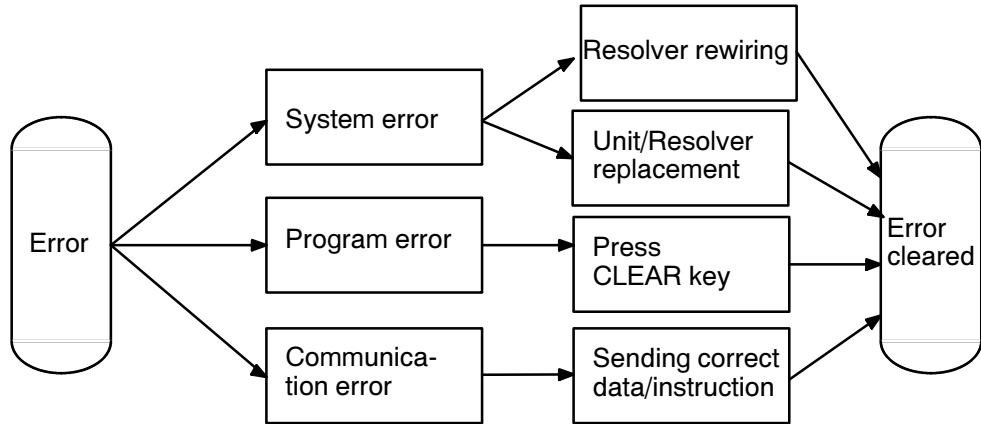

### 3-1 System Errors

System errors are caused when there is an error in the CPU, or when no input is received from the Resolver. There are five types of system error: Resolver input errors, EEPROM errors, work memory errors, work memory verification errors, and origin alignment errors. Resolver input errors and work memory verification errors are the only types of system errors that can be removed by the user.

Error code	Error type	Cause Data in EEPROM is incorrect.	Remedy
10	Resolver input error	Resolver either faulty or disconnected, or Resolver cable broken.	Reconnect Resolver or replace Resolver or cable; set mode to PProGram and press CLEAR key. In PProGram mode, all functions (except origin alignment and test run) can be used with no Resolver connected.
12	EEPROM error	Data in EEPROM is incorrect.	These errors cannot be removed by the user. Replace the Cam Positioner.
13	Work memory error	Data in work memory is incorrect.	
24	Work memory verification error	Work memory has been corrupted.	Press the CLEAR and then RUN keys. Data in EEPROM is loaded into work memory.
25	Origin alignment error	Abnormality in Resolver digital conversion circuit.	These errors cannot be removed by the user. Replace the Cam Positioner.

**Caution** Data in the work memory will be retained for two days at temperatures of up to 55°C with no power supplied to the Unit. If no power is supplied to the Unit for more than two days, the work memory may be corrupted. In this case, reload the data from the EEPROM into the work memory.

## 3-2 Program Errors

Program errors are those caused by incorrect Cam Positioner data or incorrect key input. There are eight types of program error: Cam Positioner data write errors, EEPROM write errors, origin alignment errors, protect errors, Cam Positioner data duplication errors, cam input errors, cam ON/OFF value input errors, and RUN mode changeover errors. These errors can be cleared by pressing the CLEAR key while in the PProGram mode.

Error code	Error type	Cause	Remedy
01	Cam Positioner data write error	Power source has been turned OFF without storing Cam Positioner data in EEPROM. Thus, when the power is turned back ON the data in the Cam Positioner is out of date.	If the data does not need to be stored, press the CLEAR key and start over. If the data needs to be stored, check the Cam Positioner data, and execute EEPROM write.
02	EEPROM write error	The power was turned OFF while EEPROM write was being executed. Cam Positioner data was not stored.	After checking the programmed data, execute EEPROM write again.
03	Origin alignment error	The power was turned OFF while origin alignment was being executed. When the power is turned power ON again, the origin alignment status is out of date.	If no need to realign, change to PProGram mode, press the CLEAR key and continue operating. If realignment needed, execute origin alignment again.
22	Protect error	An attempt was made to modify the data of a protected cam	If data does not need to be modified, change to PProGram mode, press the CLEAR key and continue operating. If data does need to be modified, continue operation after cancelling protection of the relevant output.
23	Cam Positioner data duplication error	A duplicate ON/OFF angle was specified for one cam	Reconfirm and correct Cam Positioner data.
26	Output number input error	Specified output has a numeric value outside the range of 0 through 31.	Reconfirm and correct Cam Positioner data.
27	Cam ON/OFF value input error	Cam ON/OFF value outside the defined area is specified, or both ON and OFF are specified at the same point.	Correct Cam Positioner data.
28	RUN mode changeover error	RUN mode has been changed over to PProGram mode.	Return to the PProGram mode initial display and then shift into RUN mode.

### 3-3 Communication Errors

Communication errors are those caused by instructions from or data transmission with the CPU. They are automatically removed when the correct data or instructions are sent by the CPU. There are three types of communication error: transmission code errors, format errors, and instruction errors.

Error code	Error type	Cause	Remedy
40	Transmission code error	Transmission code from the CPU is incorrect.	Check the transfer code number (bits 12 through 15) of the transmission data, and correct.
41	Format error	Transmission data format from the CPU is incorrect.	Confirm and correct the transmission data format.
42	Instruction error	The current instruction cannot be executed because the previous instruction is still being executed.	Check the timing of the PC program, and confirm that Cam Positioner acknowledge is received before transmitting new instructions.





# **Appendix A**

## **Specifications**

The specifications of the Cam Positioner conform to those of all C-series Programmable Controllers.

## Cam Positioner

Item	Specifications
Output points	External output: 8 points (outputs 0 through 7) Internal output: 32 points (outputs 0 through 31)
Output indication	LED indicator
External output	Transistor (open-collector, with photocoupler isolation) Switching capacity: 300 mA 12 to 30 VDC
External output terminals	10-terminal removable terminal block
Angle detector (Resolver)	3F88L-RS17/RS-17T/RS15/RS15W
Detector input terminals	15 pin sub-D connector
Control resolution	360 with 1° resolution and 720 splits with 0.5° resolution (selectable).
Max. data length	180 outputs with 1° resolution and 360 outputs with 0.5° resolution (selectable). (When all data takes the form of an ON/OFF pair.)
Response rpm	800 rpm max. (Resolver rpm)
Response time	200 μs (Sampling frequency: 5 kHz)
Repeatability	0.25
Origin alignment	0 to 359 (360 splits), 1 to 719 (720 splits)
Memory	EEPROM (8K bytes)
Current value indication	Resolver's current value shown numerically
Data input	Can be set using the keys on the front panel.
Internal current consumption	0.8 A max. 5 VDC
Mass	800 grams max.

## Power Supply Sequence

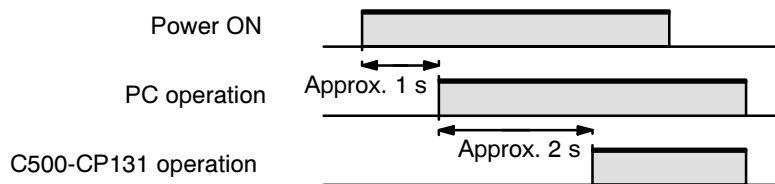

**Note** Do not operate the PC in this range. The program will run, but the Cam Positioner will not operate. Therefore, the initial scan ON flag (C500: SR bit 6115, C1000H/C2000H: SR bit 25315), if used, will not be detected by the Cam Positioner.

## External Output Circuit Configuration

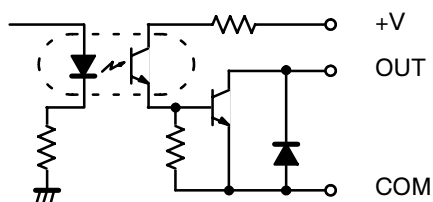

Item	Specifications
Max. switching capacity	300 mA 30 VDC
Leakage current	160 $\mu$ s A max.
Residual voltage	1.8 V max.
ON response time	2 $\mu$ s max. (See note.)
OFF response time	3 $\mu$ s max. (See note.)
Number of circuits	8 points/common, 1 circuit
External power source	40 mA min. 12 to 30 VDC

**Note** ON/OFF response times are figures for hardware. They should not be used as response times for software.



## Resolver

Item	3F88L-RS15	3F88L-RS15W	3F88L-RS17	3F88L-RS17T
Shaft diameter	6 mm		10 mm	
Axial load	Radial 10 kilograms Thrust 10 kilograms		Radial 20 kilograms Thrust 20 kilograms	
Frictional torque	30 g-cm max.		120 g-cm max.	500 g-cm max.
Response frequency	5 kHz			
Primary voltage	10 V			
Electrical mark error	10 minutes of arc			
Maximum speed	3000 rpm (Mechanical)			
Mounting	Servo-mounting (included)		Flange-mounting (Flange strength 25 kg)	
Coupling	3F88L-RL6		3F88L-RL10	
Wiring	Connector	Lead wire (350 mm)	Cable (3 m, connector included)	
Cables	3F88L-CR ___ NA	3F88L-CR ___ SA	3F88L-CR ___ C	
Color	Munsell N1.5		Munsell 5Y3/1	
Vibration	Frequency range: 10 to 500 Hz Total amplitude: 1.5 mm (or 10 G, whichever is less) Test time: X,Y,Z directions, 2 hours each			
Shock	500 G: X,Y,Z directions, 3 times each			
Ambient temperature	-10° to 80°C			
Degree of protection	Drip-proof oil retaining type, IP52F (JEM)			

## Coupling

Model	Bending angle max.	Maximum mis-alignment	Maximum transmission torque		Set screw	
			20°C	80°C	Size	Tightening torque
3F88L-RL10	105	1.0 mm	30 kg-cm	18 kg-cm	6 mm long, 4 mm diameter	4.5 kg-cm
3F88L-RL6	125	1.2 mm	10 kg-cm	6 kg-cm	4 mm long, 3 mm diameter	2.5 kg-cm

**Note** When a torque of 1.7 to 2 times the maximum transmission torque is applied, the coupling will break at the flexible plates. This is to protect the Resolver from excessive loads.

**Dimensions**  
**Cam Positioner**

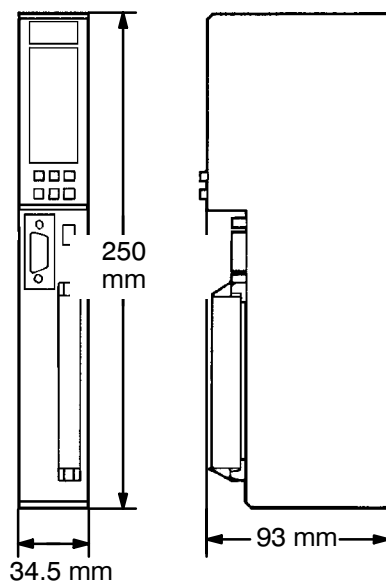

**Cam Positioner Output Terminal Block**

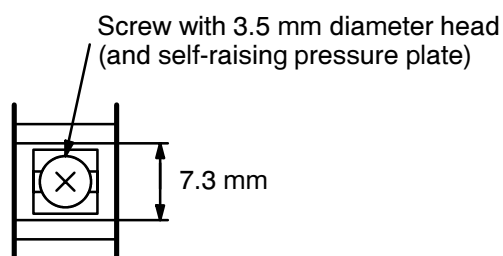

Resolvers

3F88L-RS15

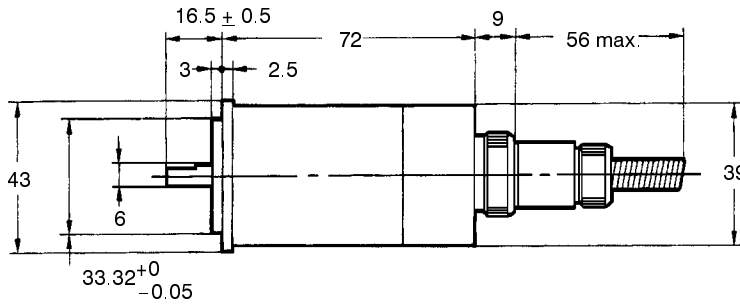
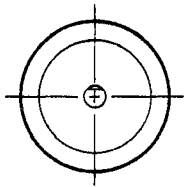

3F88L-RS15W

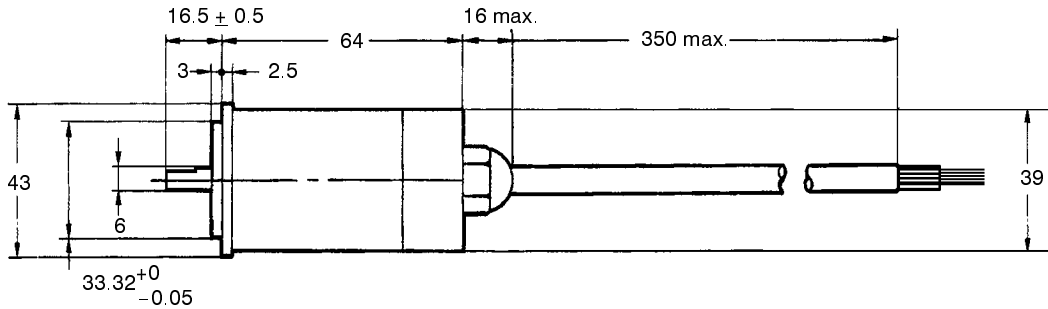
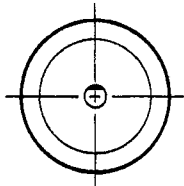

3F88L-RS17/RS17T

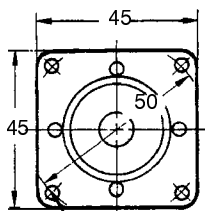

4.5 dia. (four holes)

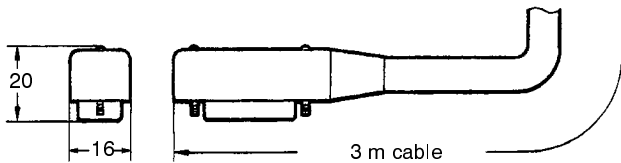
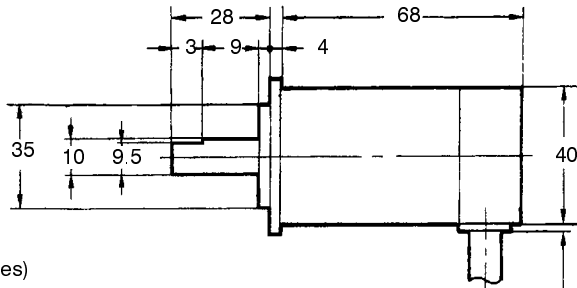

All dimensions in mm.

Coupling

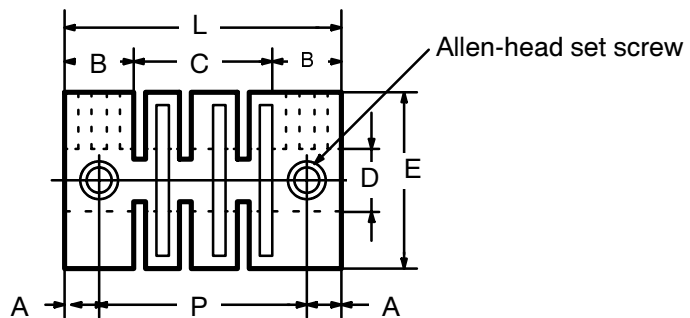

Model	Resolver	D H8	E	L	P	A	B	C	Set screw
3F88L-RL10	RS17(T)	10	22	26.2	19	3.6	7.1	12	6 mm long, 4 mm diameter
3F88L-RL6	RS15(W)	6	15	22	16.4	2.8	5.5	11	4 mm long, 3 mm diameter



# **Appendix B**

## **Standard Models**

## Products Covered in this Manual

Product Name	Description	Model Number
Cam Positioner	For C500/C1000H	C500-CP131

## Related Products

Product Name	Description	Model Number
Resolver	High torque	3F88L-17/RS17T
	With connector	3F88L-RS15
	Without connector	3F88L-RS15W
Cable (XXX indicates cable length in meters)	For High-Torque Resolver	3F88L-CRXXXC
	For Resolver with connector	3F88L-CRXXXNA
	For Resolver without connector	3F88L-CRXXXSA
Coupling	For High-Torque Resolver	3F88L-RL10
	For other Resolvers	3F88L-RL6

# Glossary

<b>back-up</b>	A copy of existing data which is valuable if data is accidentally erased.
<b>bit</b>	The smallest piece of information that can be represented on a computer. A bit has the value of either zero or one, corresponding to the electrical signals ON and OFF. A bit is one binary digit.
<b>central processing unit</b>	A device that is capable of storing a program and data, and executing the set of instructions contained in the program. In a PC System, the central processing unit executes the program, processes I/O signals, communicates with external devices, etc.
<b>controlled system</b>	The devices that are being controlled by a PC System.
<b>counter</b>	A PC function that counts the number of occurrences of a certain event.
<b>CPU</b>	An acronym for central processing unit.
<b>CPU Rack</b>	Part of a Rack PC, the CPU Rack contains the CPU, a Power Supply, and other Units.
<b>EEPROM</b>	[E(lectrically) E(rasable) P(rogrammable) R(ead) O(nly) M(emory)] A type of ROM in which stored data can be erased and reprogrammed. This is accomplished using a special control lead connected to the EEPROM chip and can be done without having to remove the EEPROM chip from the device in which it is mounted.
<b>EPROM</b>	[E(rasable) P(rogrammable) R(ead) O(nly) M(emory)] A type of ROM in which stored data can be erased, by ultraviolet light or other means, and reprogrammed.
<b>Expansion I/O Rack</b>	Part of a Rack PC, an Expansion I/O Rack is connected to a CPU Rack to increase the number of slots available for mounting Units.
<b>flag</b>	A bit that is turned ON and OFF automatically by the system in order to provide status information.
<b>Intelligent I/O Functions</b>	Functions which let the CPU of the PC read data directly from and write data directly to the internal memory of a Special I/O Unit or Intelligent I/O Unit.
<b>I/O table</b>	Diagram written to the IR memory area listing the type of I/O units controlled by a PC. It must be cleared before programming or when I/O units are changed. Tables can be read, verified, or transferred to a EPROM.
<b>I/O Unit</b>	The most basic type of Unit mounted to a Backplane. I/O Units include Input Units and Output Units, each of which is available in a range of specifications. I/O Units do not include Special I/O Units, Link Units, etc.
<b>LOAD instruction</b>	Starts the operation of a line of programming. Each new line off the bus bar has an address number, a LD instruction, and a relay number.
<b>OUT instruction</b>	Outputs the result of a logical operation to a specified bit.
<b>PC</b>	An acronym for Programmable Controller.



<b>Programmable Controller</b>	A small, computer-like device that can control peripheral equipment, such as an electric door or quality control devices, based on programming and peripheral input devices. Any process that can be controlled using electrical signals can be controlled by a PC. PCs can be used independently or networked together into a system to control more complex operations.
<b>PROM</b>	[P(rogrammable) R(ead) O(nly) M(emory)] A type of ROM into which the program or data may be written after manufacture, by a customer, but which is fixed from that time on.
<b>PROM Writer</b>	A PROM Writer is a device used to write data to ROM, PROM, and EPROM storage chips.
<b>Rack</b>	An assembly that forms a functional unit in a Rack PC System. A Rack consists of a Backplane and the Units mounted to it. These Units include the Power Supply, CPU, and I/O Units. Racks include CPU Racks, Expansion I/O Racks, and I/O Racks. The CPU Rack is the Rack with the CPU mounted to it. An Expansion I/O Rack is an additional Rack that holds extra I/O Units. An I/O Rack is used in the C2000H Duplex System, because there is no room for any I/O Units on the CPU Rack in this System.
<b>RAM</b>	[R(andom) A(ccess) M(emory)] RAM will not retain data when power is disconnected. Therefore data should not be stored in RAM.
<b>register/registered</b>	Storing text and graphics in the RAM/ROM card from a personal computer or the ASCII Unit. Graphics that have been written to the RAM/ROM card are referred to as registered messages.
<b>ROM</b>	[R(ead) O(nly) M(emory)] A type of digital storage that cannot be written to. A ROM chip is manufactured with its program or data already stored in it, and it can never be changed. However, the program or data can be read as many times as desired.
<b>scan time</b>	The total time it takes the PC to perform internal operations, i.e., reset the watchdog timer, read the program, receive input data, send output data, and execute instructions. Scan time is monitored by the watchdog timer within the PC, and if it takes longer than a certain specified amount of time, an error message may be generated, or the CPU may just stop. Scan times will differ depending on the configuration of the system.
<b>solenoid</b>	An output device consisting of closely wound insulating wire, in the form of a cylinder, but not necessarily circular. It is generally used in conjunction with an iron core, which is pulled into the cylinder by the magnetic field set up when current is passed through the core.
<b>Special I/O Unit</b>	A dedicated Unit that is designed for a specific purpose. Special I/O Units include Position Control Units, High-speed Counters, Analog I/O Units, etc.
<b>system configuration</b>	The arrangement in which Units in a System are connected. This term refers to the conceptual arrangement and wiring together of all the devices needed to comprise the System. In OMRON terminology, system configuration is used to describe the arrangement and connection of the Units comprising a Control System that includes one or more PCs.
<b>Unit</b>	In OMRON PC terminology, the word Unit is capitalized to indicate any product sold for a PC System. though most of the names of these products end with the word Unit, not all do, e.g., a Remote Terminal is referred to in a collective sense as a Unit. Context generally makes any limitations of this word clear.

**watchdog timer**

A special timer inside the CPU that monitors the PC's scan time. The watchdog timer sets a flag if the scan time becomes longer than a certain specified value. This is useful if the correct operation of your System depends on a certain maximum scan time.

**word**

In digital circuits, a group of bits. Usually a word consists of four, eight, or sixteen bits. In C-series PCs, a word consists of sixteen bits. Words can be used to store data, or they can be used for I/O.



# INDEX

## B

Back-up, battery, 12

### Bit

- Allocation, 16
- four-word mode, 41
- instruction functions, 18
- name, 18, 19

## C

Controlled System, 5

Counter, 43

CPU, control, 15

## E

EEPROM, 4, 12, 13, 15, 18, 19

EEPROM Error, 47

### Error

- communication, 49
- error code transfer
  - four-word mode, transfer format, program example, 50
  - two-word mode, 50
- general, 47
- program, 48
- system, 47

Expansion I/O Rack, 36

## F

Flag, 16, 19

### Functions

- implementation, 13
- overview, 12

## H

### Hardware

- assembly of, 5
- CPU, 2
- description of, 2
  - Back Panel, 3
  - Front Panel, 2
  - internal diagram, 4
- I/O Unit, 2

Programmable Controller (PC), 2

solenoid, 5, 6

system connections, 6

Cam Positioner wiring, 9

coupling, 10

precautions, 6

Resolver wiring, 7

### Unit

Chuck, 5

DC Input, 5

## I

Intelligent I/O Functions, 16, 36

## K

### Key sequences

functions, 22

general, 21

local mode, 22

entering, 23

program mode

bank changeover, 30

bank clear, 29

Cam Positioner data modification, 26, 27

Cam Positioner data read, 25

cam protect, 32

display of origin alignment, 31

entering, 24

teaching, 27

test run, 34

run mode, 22

entering, 35

status display, 21

## L

Load Instructions, 12

## O

### Operation, 15

bit allocation

four-word mode, 17

two-word mode, 16

data configuration, 15

data transfer, 19

instruction bit functions

command, 18

status, 19

## **P**

### **Programming**

#### four-word mode

Cam Positioner data deletion, delete format

all step deletion, 44

delete program, 44

single step deletion, 44

data memory allocation, 42

general, 41

ladder diagram, 43

read program example, ladder diagram program, 45

reading of output and current angle, 44

write program example, 42

general, 36

#### two-word mode

Cam Positioner data write/delete format, 37

data memory allocation, 38

general, 37

ladder diagram, 39

output/current angle/error code read format, 39

read program example, 40

write programming example, 38

## **R**

Register, 5, 27

## **S**

Scan Time, 38

Scan time, 2

Switch, settings, 13

examples, 13

360 splits, 13

720 splits, 14

## **W**

Watchdog Timer, 19

# Manual Revision History

The manual revision code appears as a suffix to the catalog number on the cover of each manual.

Cat. No. W144-E1-2



Revision code

Revision code	Date	Revision content	Ref. Mat.
1	Nov. 1988	Original production	29-132
2	Feb. 1990	Complete revision of the entire manual with emphasis on the writing.	29-132B